

16" H61 Reeded with End Caps Back to Back Shower Door Pull

Model #: H61-BB-16-

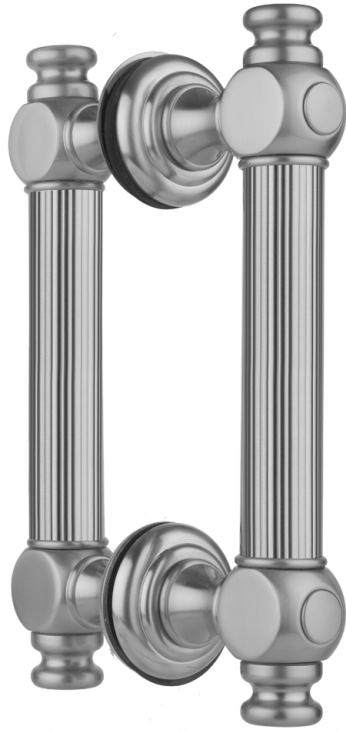

FEATURES:

- Can be mounted vertically or horizontally
- Can be used as a towel bar when mounted horizontally
- Not to be used as a grab bar
- All brass construction, full polished & plated
- Includes rubber gaskets for glass door installation
- Custom sizes available- Contact JACLO for pricing & availability

AVAILABLE FINISHES:

Polished Chrome (PCH)	Satin Chrome (SC)	Bronze Umber (BU)
Satin Nickel (SN)	Pewter (PEW)	Caramel Bronze (CB)
Polished Nickel (PN)	Antique Brass (AB)	Antique Copper (ACU)
Oil-Rubbed Bronze (ORB)	Polished Brass (PB)	Polished Copper (PCU)
Vintage Bronze (VB)	Satin Brass (SB)	Rose Gold (RG)
Matte Black (MBK)	Satin Gold (SG)	Polished Gold (PG)
Black Nickel (BKN)	Bombay Gold (BG)	Jewelers Gold (JG)
Europa Bronze (EB)	White (WH)	Sedona Beige (SDB)
Tristan Brass (TB)	Unlacquered Brass (ULB)	Satin Cooper (SCU)

SPECIFICATION DRAWING:

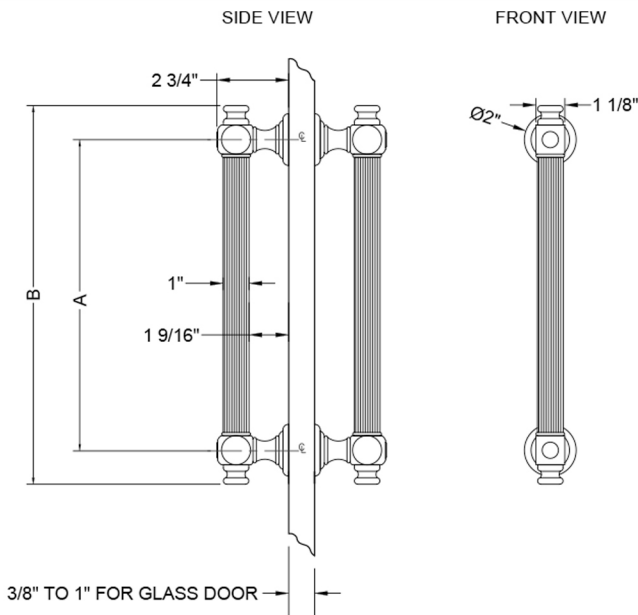

BRASS LUXURY BACK TO BACK DOOR PULL			
PART. #	DESCRIPTION	A	B
H61-BB-	6" CENTER TO CENTER	6"	8 5/8"
H61-BB-8	8" CENTER TO CENTER	8"	10 5/8"
H61-BB-12	12" CENTER TO CENTER	12"	14 5/8"
H61-BB-16	16" CENTER TO CENTER	16"	18 5/8"
H61-BB-18	18" CENTER TO CENTER	18"	20 5/8"
H61-BB-24	24" CENTER TO CENTER	24"	26 5/8"
H61-BB-32	32" CENTER TO CENTER	32"	34 5/8"