

Tools Required

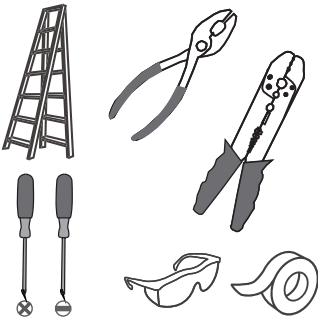

Light Source

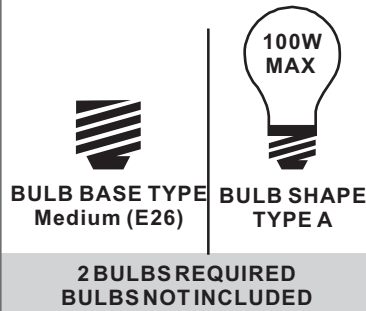

Warnings and Cautions

Turn off the electricity at the circuit breaker before installation. Consult a licensed electrician if in doubt about installation.

Turn off power to the fixture and allow the bulbs to cool before replacing.

Package Contents

Preparation: Identify and inspect all parts before beginning the installation.

Missing or damaged parts? Contact your original place of purchase.

PARTS BAG

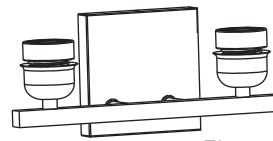
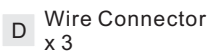
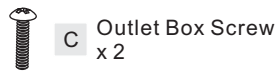
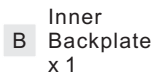
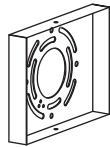
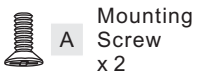

E Fixture Body x 1



G Socket Collar x 2



F Glass Shade x 2

Table of Contents

Inner Backplate

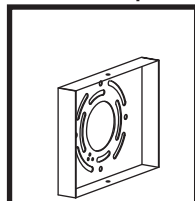

STEP 1

Wiring

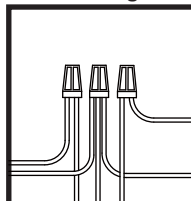

STEP 2

Fixture Body

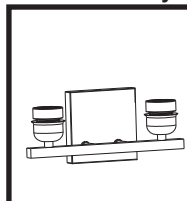

STEP 3

Shade & Bulb

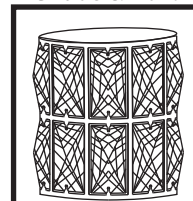

STEP 4

STEP 1

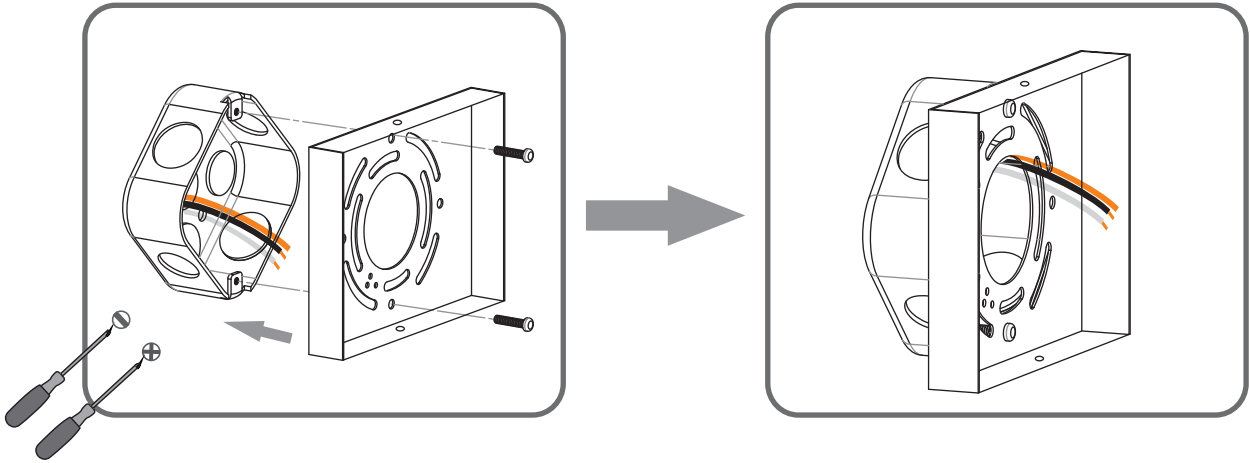

STEP 2

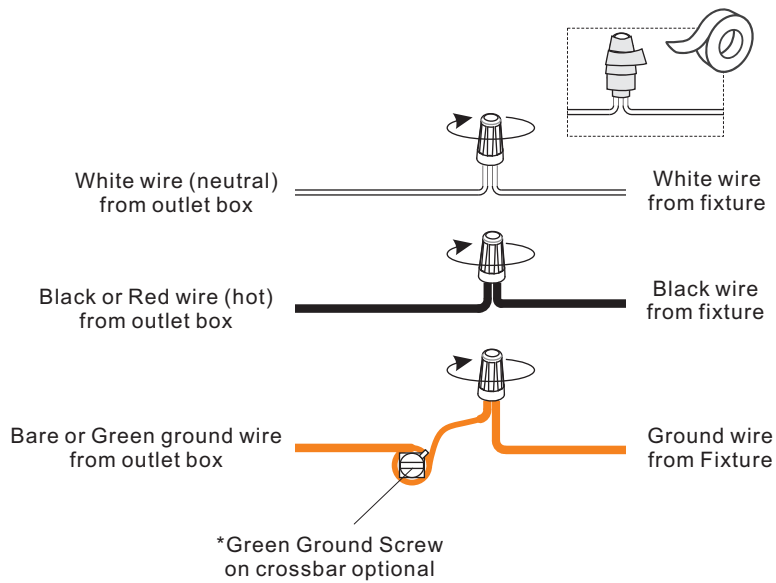

STEP 3

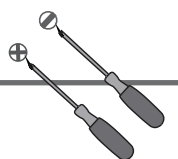
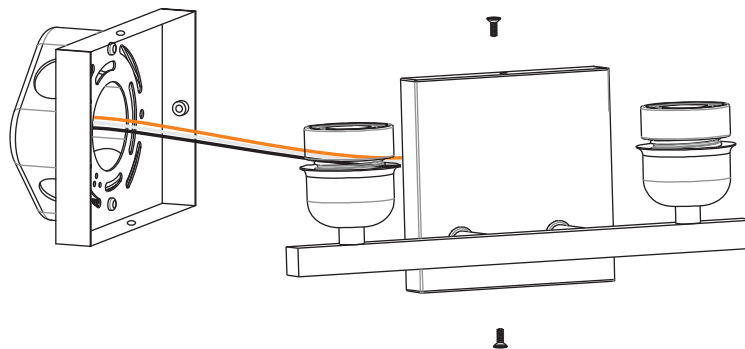

STEP 4

