

Tools Required

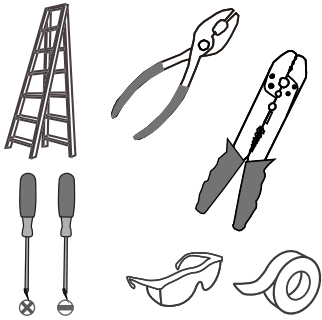

Light Source

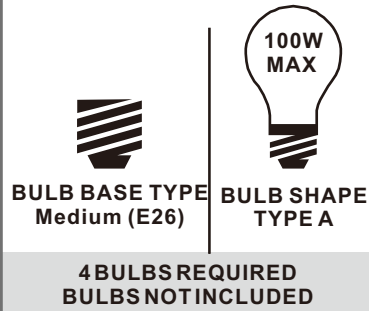

Warnings and Cautions

Turn off the electricity at the circuit breaker before installation. Consult a licensed electrician if in doubt about installation.

Turn off power to the fixture and allow the bulbs to cool before replacing.

Package Contents

Preparation: Identify and inspect all parts before beginning the installation.

Missing or damaged parts? Contact your original place of purchase.

PARTS BAG

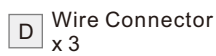
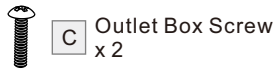
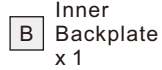
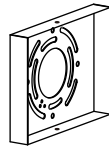
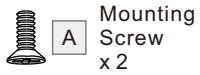

E Fixture Body x 1



G Socket Collar x 4



F Glass Shade x 4

Table of Contents

Inner Backplate

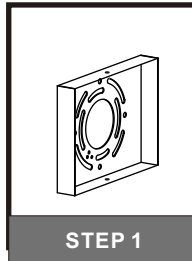

Wiring

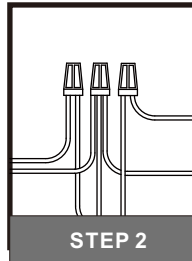

Fixture Body

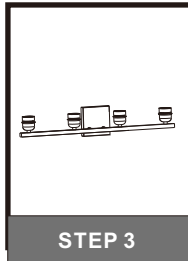

Shade & Bulb

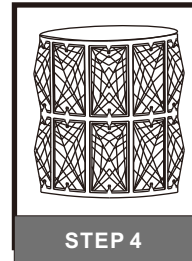

STEP 1

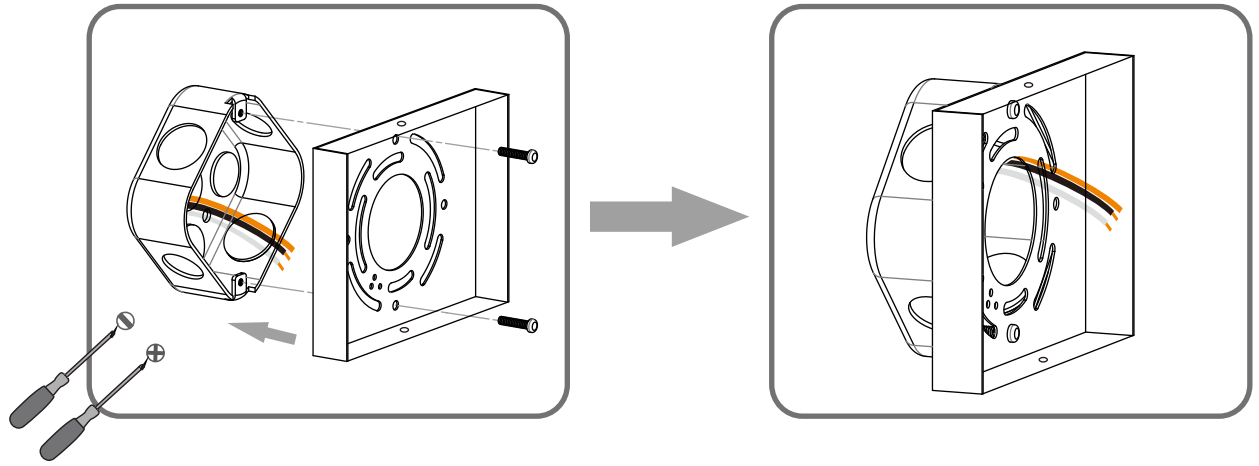

STEP 2

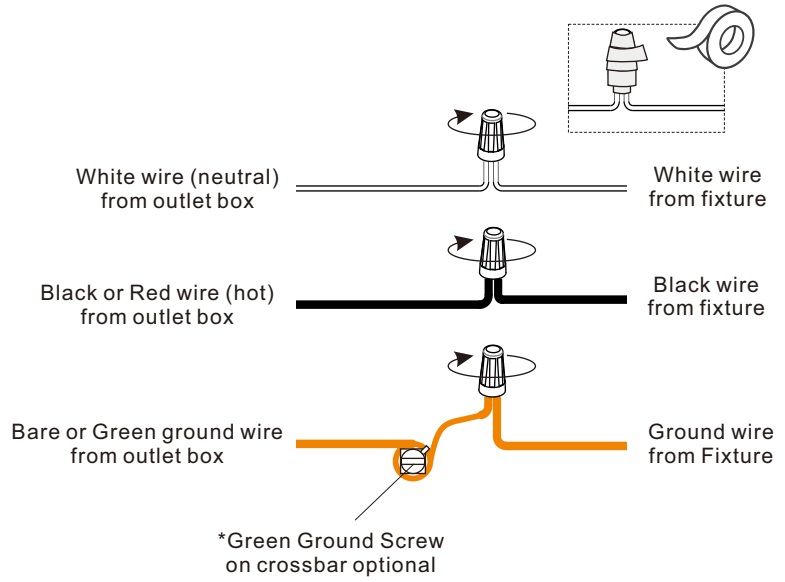

STEP 3

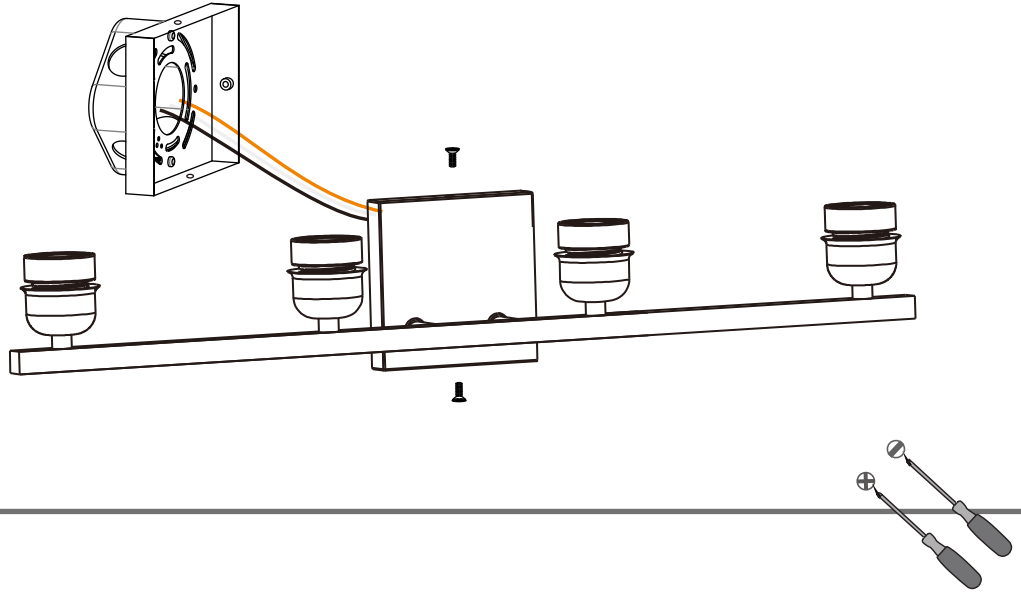

STEP 4

