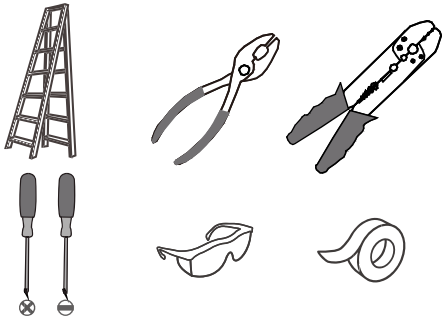


**Tools Required**



**Light Source**

**17W  
LED**

**⚠ Warnings and Cautions**

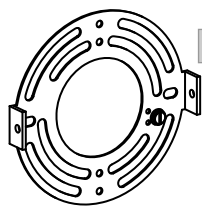
Turn off the electricity at the circuit breaker before installation. Consult a licensed electrician if in doubt about installation.

**Package Contents**

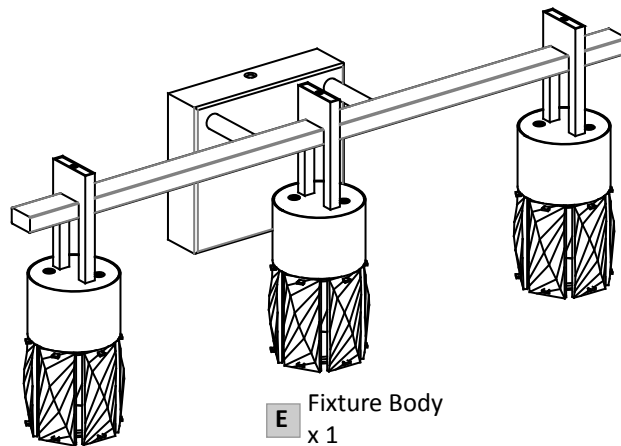
**Preparation:** Identify and inspect all parts before beginning the installation.

**Missing or damaged parts?** Contact your original place of purchase.

**PARTS BAG**

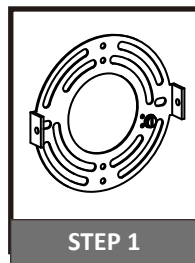


- A** Crossbar x 1
- B** Mounting Screw x 2
- C** Outlet Box Screw x 2
- D** Wire Connector x 3

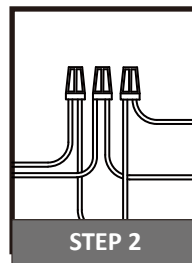


**Table of Contents**

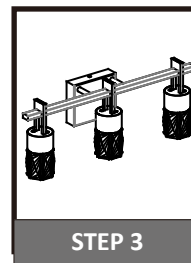
**Crossbar**



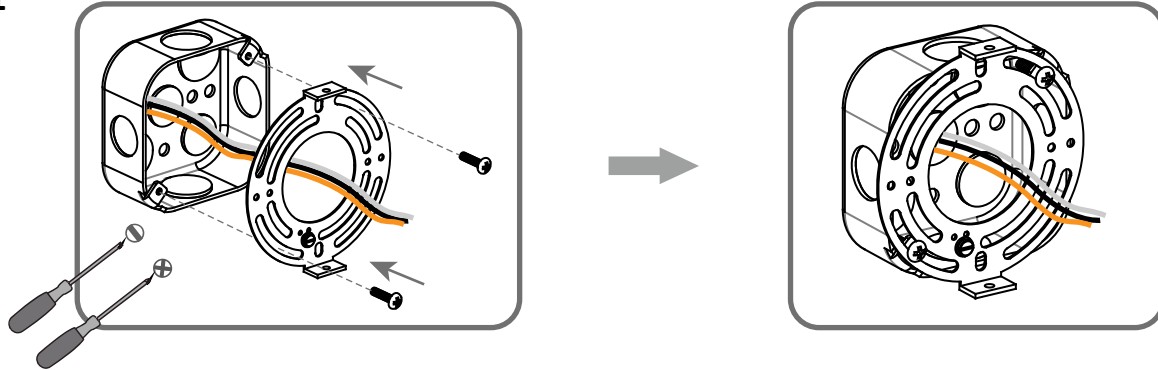
**Wiring**



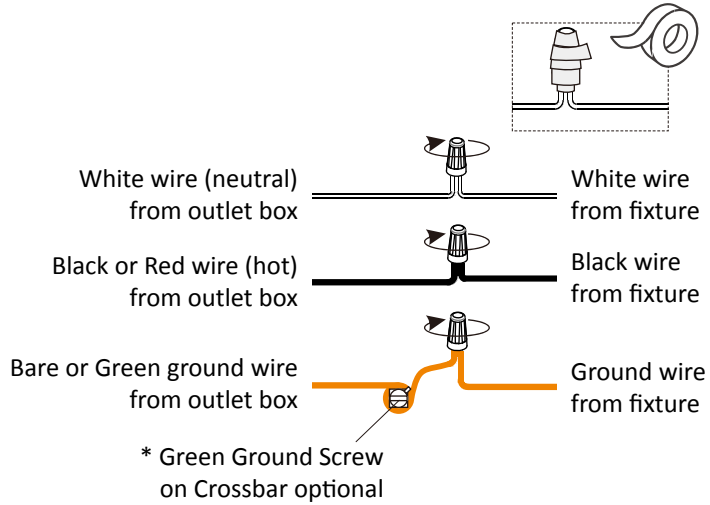
**Fixture Body**



### STEP 1



### STEP 2



### STEP 3

