

SAMUEL HEATH

Product Number: N6647W

Description: White ceramic soap dispenser



Finishes Available



Chrome Plate



Polished Nickel



Non Lacquered
Brass



Antique Gold



Stainless Steel
Finish



City Bronze



Country Bronze



Brushed Gold
Gloss



Brushed Gold Matt



Brushed Gold
Unlacquered

Control Options Available



Specification Drawing

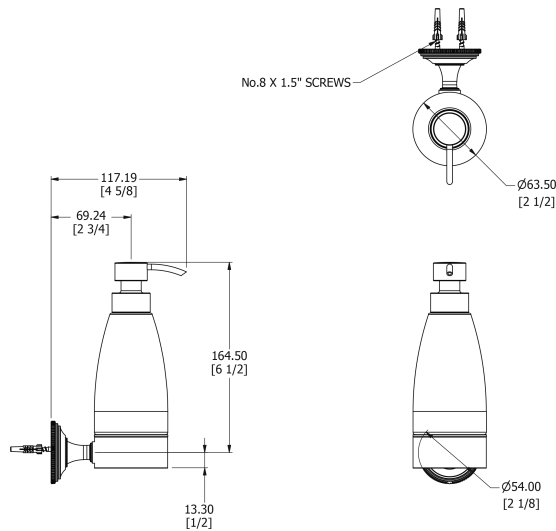

UK Customer Service

Leopold Street
Birmingham
B12 0UJ
Tel: +44 121 766 4200
Email: info@samuel-heath.com

US Customer Service

Federal I.D. No. 58-1504682
Email: usa@samuel-heath.com

Specification Enquiries

Design Centre Chelsea Harbour
1st Floor, North Dome, London
SW10 0XE
Tel: 020 7352 0249
Email: showroom@samuel-heath.com

1-05/09/2019