

THE **GALLEY** TAP.®

Galley BarTap® Installation Guide

Before You Begin Installation

INSTALLATION WARNING: NEVER USE TEFLON TAPE FOR OUT-OF-THE-WALL THREADED CONNECTIONS. USE PROVIDED RUBBER GASKETS ONLY. NOT COMPLYING WITH THIS INSTRUCTION COULD DAMAGE THE PRODUCT AND GENERATE LEAKAGE.

1. Observe all local plumbing codes.
2. Turn off water supply.
3. Inspect water supplies for signs of damage. Replace if necessary.
4. DO NOT use petroleum-based products on this faucet.

Tools



#2 & #3 PHILLIPS SCREWDRIVERS



ADJUSTABLE WRENCH



ADJUSTABLE PLIERS

Package Contents

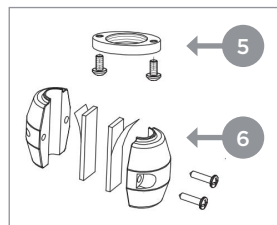
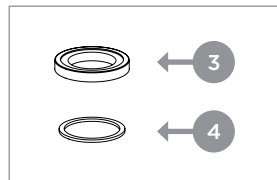
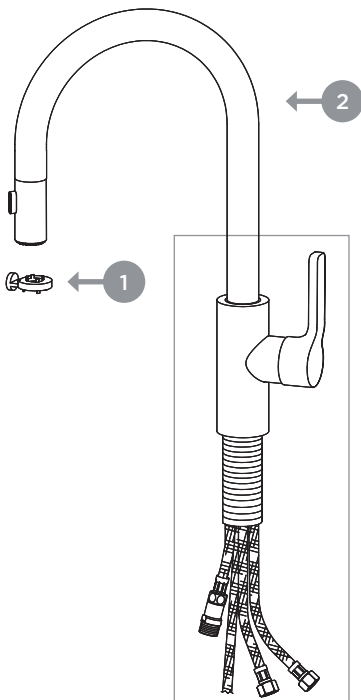

Remove all contents from the package and identify before installation.

- 1 - Aerator Key
- 2 - Faucet
- 3 - Optional Base Ring
- 4 - Stainless Steel Mounting Washer
- 5 - Stainless Steel Mounting Nut with Two Crosshead Screws
- 6 - Counterweight with two rubber strips

Note: All Hoses come pre-installed into Faucet and are water tested at the factory.

TECHNICAL INFORMATION

Recommended Pressure Range: 20PSI - 75PSI
Maximum Flow Rate: 1.8GPM / 6.8L /min
Maximum Temperature: 150° F

Product is Certified to NSF/ ANSI 372 and conforms with the lead content requirements for "lead free" plumbing as defined by California, Vermont, Maryland, and Louisiana state laws and the U.S. Safe Drinking Water Act. This faucet complies with ASME 112.18.1-2018/CSA B125.1-2018 requirements.



Installation

Step 1

The Galley BarTap. comes with an Optional Base Ring. It can be installed with the Base Ring or without it.

Optional Base Ring
Mounting Shank

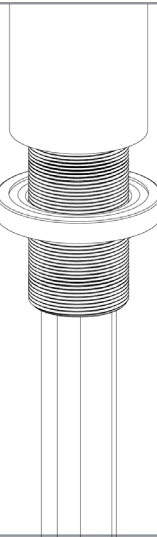

Step 2

Insert all hoses and Mounting Shank through the hole in counter top.

Ø 1-3/8" drill hole in counter top
Ø 1-1/2" fast water jet hole in counter top

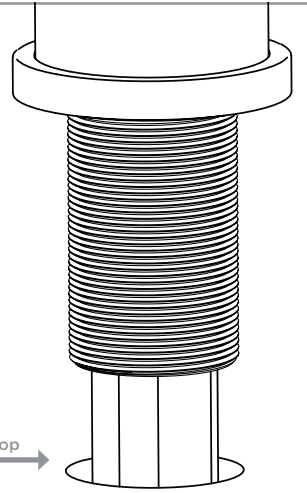

Step 3

On the underside of the counter top, install the stainless steel Washer and Mounting Nut by slipping them over the hoses and threading the nut onto the Mounting Shank. Tighten the Mounting Nut against the counter top and tighten the two screws so the faucet is secure.

Stainless Steel Washer
Stainless Steel Mounting Nut
Stainless Steel Crosshead Screws

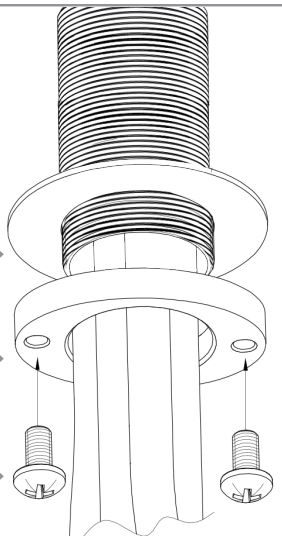

Step 4

Connect the Hand Spray Hose to the Hand Spray Supply Hose on which the Check Valve housing is fitted.

Hand Spray Supply Hose
Check Valve Housing
Hand Spray Hose

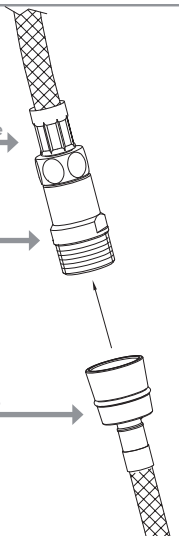

Note: make sure the Hand Spray Hose and Counterweight are free to extend or retract and are not in conflict with any plumbing components or items under the sink or Workstation.

Step 5

Install the Counterweight onto the Hand Spray Hose as shown.

Proper placement of the Counterweights is critical for the proper retraction of the spray hose.

Hand Spray Hose

H
C

VERY IMPORTANT!

1"

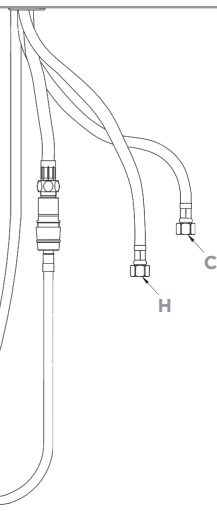

Step 6

Before connecting the hot and cold Supply Hoses, flush water supply stops to clear any debris. Place a bucket underneath the stops and run water for 5 to 10 seconds. Carefully turn on the water.

Carefully position hot and cold supplies so they will not interfere with other hoses.

Connect the 3/8" Compression Connections (Hot and Cold Supply Hoses) to your hot and cold inlets. Hoses are marked hot and cold.

Cold Supply
Hot Supply

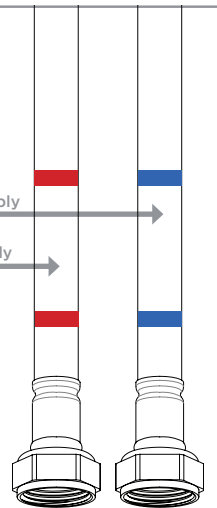

Usage

- Faucet turns on by tilting Handle out. Tilting angle is 24°. Handle rotates forward for temperature adjustment.
- When Handle is in upright position, water temperature is fully cold. When Handle is rotated 90° forward, water temperature is fully hot.
- Adjust Slide Switch down for spray flow or up for laminar flow.

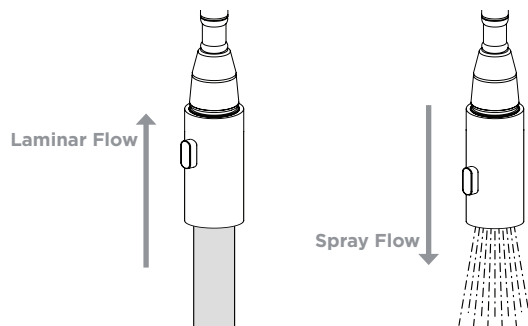
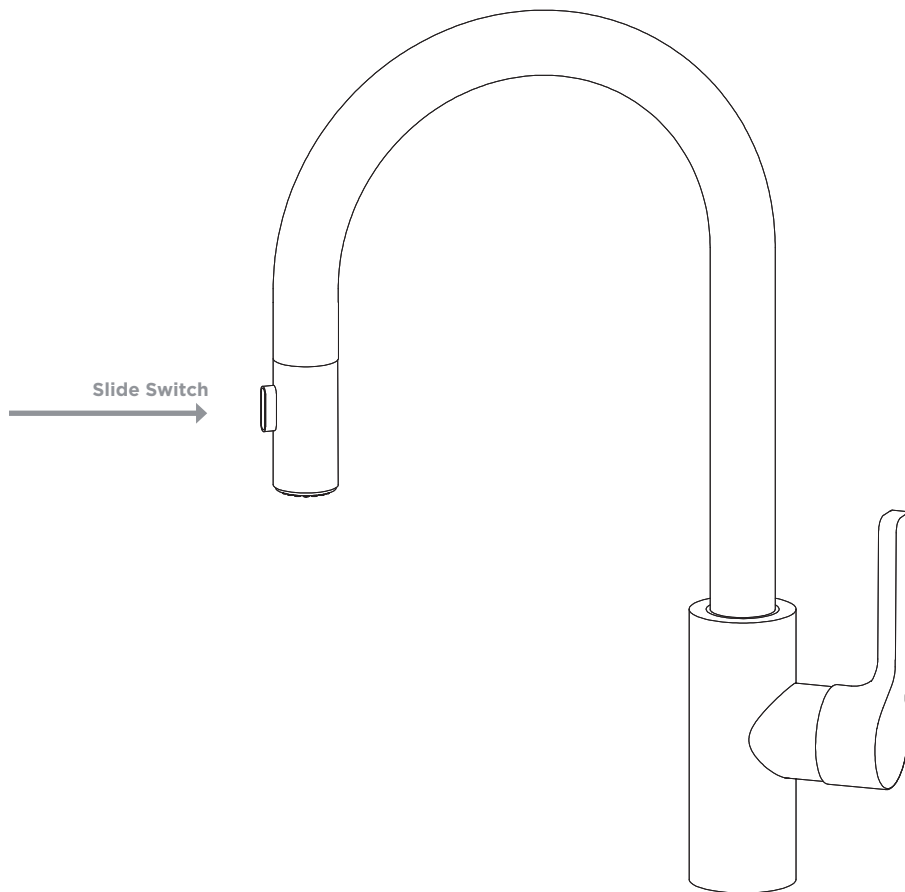

Maintenance: Indoor Installation

1. CARTRIDGE REPLACEMENT:

- Using an Allen Key, unthread Set Screw from handle
- Unthread and remove Dome Cap and Cartridge Nut.
- Remove and replace Cartridge. Use the 2 pins on the bottom of the Cartridge to seat the Cartridge correctly.

2. CHECK VALVE REPLACEMENT:

- Unthread Hose and Check Valve Housing.
- Remove and replace Check Valves by inserting them O-Ring side forward into Check Valve Housing.
- Re-assemble.

3. AERATOR REPLACEMENT:

- Use Aerator Key to remove and replace Aerator.

4. AERATOR CLEANING:

- Clean aerator periodically to eliminate any build-up.

Maintenance: Outdoor Installation

1. CARTRIDGE REPLACEMENT:

- Using an Allen Key, unthread Set Screw from handle
- Unthread and remove Dome Cap and Cartridge Nut.
- Remove and replace Cartridge. Use the 2 pins on the bottom of the Cartridge to seat the Cartridge correctly.

2. CHECK VALVE REPLACEMENT:

- Unthread Hose and Check Valve Housing.
- Remove and replace Check Valves by inserting them O-Ring side forward into Check Valve Housing.
- Re-assemble.

3. AERATOR REPLACEMENT:

- Use Aerator Key to remove and replace Aerator.

4. AERATOR CLEANING:

- Clean aerator periodically to eliminate any build-up.

Important - Your outdoor Galley BarTap, must be winterized if temperature falls below freezing in your area.

5. WINTERIZE YOUR GALLEY BARTAP:

- Turn off water supply under the counter and disconnect Hot and Cold Supply Hoses.
- Disconnect Check Valve Housing and Hand Spray Supply Hose (see picture below); remove both Check Valves.
- Open handle and pull out Hand Spray from spout to drain any water; drain completely.

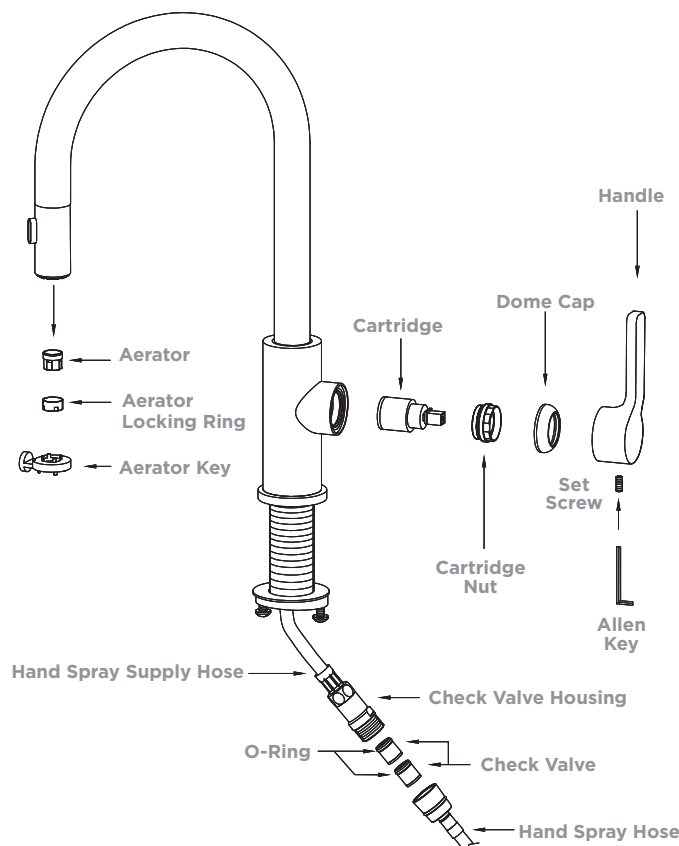

Care and Cleaning the Galley BarTap® Finishes

ABOUT OUR FINISHES:

The Galley BarTap is made of solid stainless steel. This finish has NO PROTECTIVE COATING on it. Stainless steel is by its material nature very tarnish-resistant, but by no means tarnish or stain proof. This finish will react to it's environment over time. Cleaners that contain bleach may cause rust. Keep your Galley BarTap wiped clean and dry, and use only a cleaner specifically made for stainless steel. Trapped moisture on the surface of your finish can lead to staining. Astringent cleaners, chlorine, bleach, and acidic-based organic cleansers are potentially harmful to stainless steel finishes.

IMPORTANT NOTICE:

It is the responsibility of the customer to check for any material finish defects BEFORE installation.

SUGGESTED FINISH MAINTENANCE PROCEDURE:

1. Do not allow water spots to dry on the fixture. Keep the surface clean and dry after use.
2. Periodic cleaning can be done by applying a stainless steel cleaner with a soft, clean cloth to gently remove surface spots and brighten the finish. For PVD finishes, clean with a soft, warm, damp cloth.
3. Never use cleaners with bleach, abrasives or vinegar. Never use any type of abrasive cleaning pad.

Replacement Parts

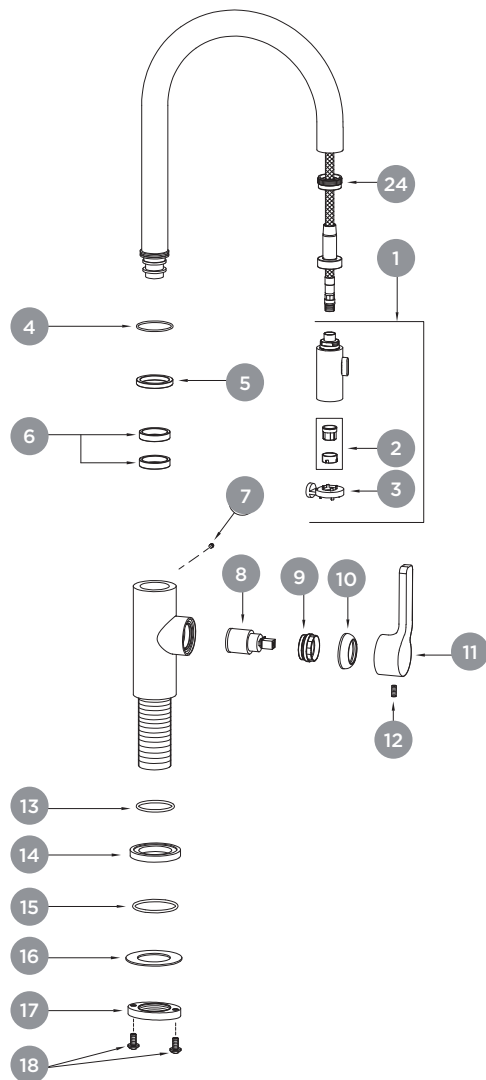

* XXX Represents Finish

1.	Hand Spray	X.1062-XXX
2.	Aerator & Ring	A.363
3.	Aerator Key	S.203
4.	O-Ring Gasket	O.021
5.	Acetal Ring	S.
6.	Acetal Ring	S.241
7.	Set screw	A.128
8.	Cartridge	S.232
9.	Cartridge Nut	B.709
10.	Dome Cap	B.710-XXX
11.	Handle	F.019-XXX
12.	Set screw	A.356
13.	O-Ring Gasket	O.066
14.	Base Ring	B.711-XXX
15.	O-Ring Gasket	O.022
16.	Mounting Washer	A.358
17.	Mounting Nut	F.016
18.	Mounting Nut Screws	A.357
19.	Gasket	A.064
20.	Counterweight	S.252
21.	Adhesive Strips	S.273
22.	Check Valve	A.290
23.	Hand Spray Hose	A.344
24.	Centering Ring	X29.1083

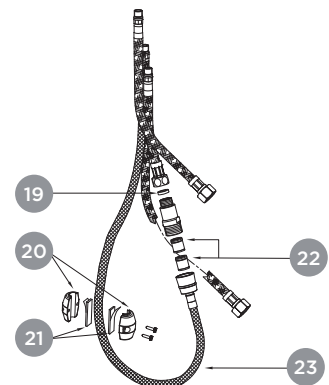

The Galley Tap - Limited Lifetime Warranty

1. GALLEY TAP LIMITED LIFETIME MECHANICAL WARRANTY —

Seller provides a Limited Lifetime Mechanical Warranty. Seller warrants its products, installed in a residential application, to be free from manufacturing defects in materials and workmanship under normal usage for the useful life of the product. This Limited Lifetime Mechanical Warranty is subject to the warranty conditions and limitations as set forth below.

2. GALLEY TAP LIMITED LIFETIME FINISH WARRANTY —

Seller provides a Limited Lifetime Finish Warranty. For the following Finishes: Polished Stainless Steel, Matte Stainless Steel, PVD Satin Black Stainless Steel, PVD Gun Metal Gray™ Stainless Steel, PVD Polished Rose Gold Stainless Steel and PVD Brushed Gold Stainless Steel, seller warrants its finishes, installed in a residential application, to be free from manufacturing defects in materials or workmanship for the useful life of the product. Please refer to the Seller's Care Instructions for the proper maintenance of Seller's finishes. This Limited Lifetime Finish Warranty is subject to the warranty conditions and limitations as set forth below.

3. WARRANTY CONDITIONS AND LIMITATIONS —

Seller's Mechanical and Finish warranties are non-transferable and are strictly limited to products correctly installed using our installation instructions and used in a residential environment. Mechanical or finish problems which result from abuse, misuse, improper installation, improper maintenance, (including not properly winterizing the Tap in outdoor installations), improper cleaning, proximity to bodies of saltwater, or accidental damage such as scuffs and scratches are not covered by this warranty. Seller does not assume liability for labor charges, removal and reinstallation expenses, freight or postage charges, or injuries resulting from a defective product. This warranty does not allow recovery of incidental or consequential damages such as loss of use, property damage, or any other consequential damage and Seller accepts no liability for such damage. Seller does not assume any responsibility other than to repair or replace the defective part(s) after Seller, upon its examination, has determined the product to be defective and the defective part(s) are covered by the Limited Lifetime Warranty expressed in this warranty. Whether to repair or replace the product shall be at the sole election of the Seller. In no event shall the liability of The Galley exceed the purchase price of the Tap. The use of Plumber's Putty will void this warranty. A non-corrosive epoxy silicone sealing compound may be used. Seller hereby disclaims all other warranties, expressed or implied, other than those set forth in this warranty. Some states do not allow the exclusion or limitation of incidental or consequential damages, so the above limitation or exclusion may not apply to you. This warranty gives you specific legal rights and you may also have other rights which vary from state to state.

4. WARRANTY CLAIMS —

These warranties are in effect for Seller's Products purchased on January 1st, 2017 and thereafter. For warranty claims, please contact your Galley Dealer, or you may write to:

The Galley, LLC.
Attn: Warranty Claims
12626 South Memorial Drive
Bixby, OK 74008

Please include the original receipt with a description of the problem, model number, store, date of purchase, your name, address and telephone number.



Corporate Headquarters

The Galley, LLC.
12626 South Memorial Drive
Bixby, OK 74008
800.375.4255
thegalley.com