

FR Garniture pour mitigeur thermostatique THG avec inverseur 2 sorties ref. 5500AE avec boîtier d'encastrement

EN Trim for THG thermostat with stop valve and 2 way diverter, -ref. 5500AE with box for rough parts

CN 恒温混合阀THG带分流器2出口ref.5 500AE带冲洗安装盒

DE Garnitur für Unterputz-Thermostat THG, Ref. 5500AE, mit Temperatureinstellung, Absperr- und 2-Wege-Umstellfunktion

ES Parte exterior del termostático con un inversor y 2 salidas (para ref 5500AE con caja de empotrar)

IT Guarnizione per valvola miscelatrice termostatica THG con invertitore a 2 uscite rif.5 500AE con scatola da incasso

NL Pakking voor thermostatische mengkraan THG met omleider 2 uitgangen ref.5 500AE met inbouwbehuizing

RU Гарнитура для терmostатического смесителя THG с инвертором, 2 выходами арт.5 500AE с корпусом для встройки

AR تجهيزات إضافية للخلاط المنظم للحرارة THG مع محول لديه مخرجين الرمز المرجعي 5500AE مرفق بصندوق الدمج

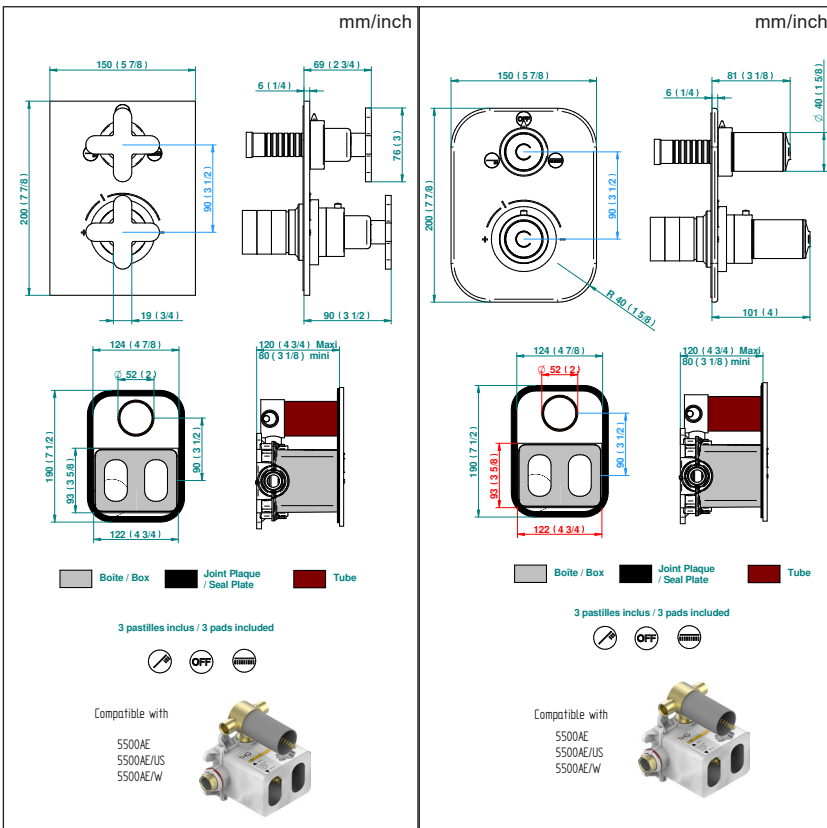

Outillage (Non-fourni)

Tools (Not provided)

工具 (自备)

Werkzeuge (Nicht mitgeliefert)

Herramientas (no suministradas)

Utensili (non forniti)

Gereedschap (Niet meegeleverd)

инструменты (Не обеспечен)

الأدوات (غير مرفقة)

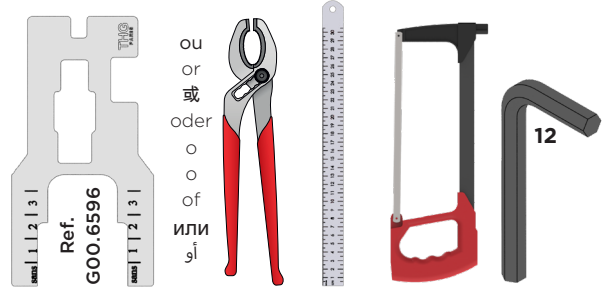

Assurez vous d'avoir purgé les canalisations et vérifié l'étalonnage de la cartouche

Make sure you have purged the water pipes, and checked the calibration of the cartridge

确保已清空管道并检查滤芯的校准

Stellen Sie sicher, dass Sie die Kanäle gespült und die Kalibrierung der Kartusche überprüft haben

Asegúrese de que ha limpiado los conductos y verificado la calibración del cartucho

Assicurarsi di aver spurgato le condutture e controllato la calibrazione della cartuccia

Zorg ervoor dat u de leidingen hebt ontluicht en de kalibratie van de cartouche hebt gecontroleerd

Убедитесь, что вы прочистили трубопроводную сеть и проверили калибровку картриджа

تري اءم نمر ققحت و تاونقلا ري هطت نمر دكأت دش وطرخل

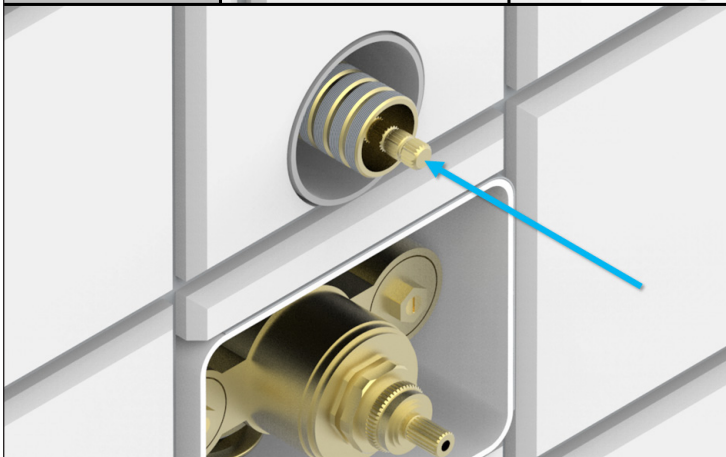
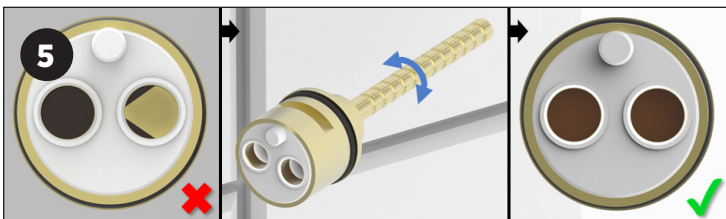
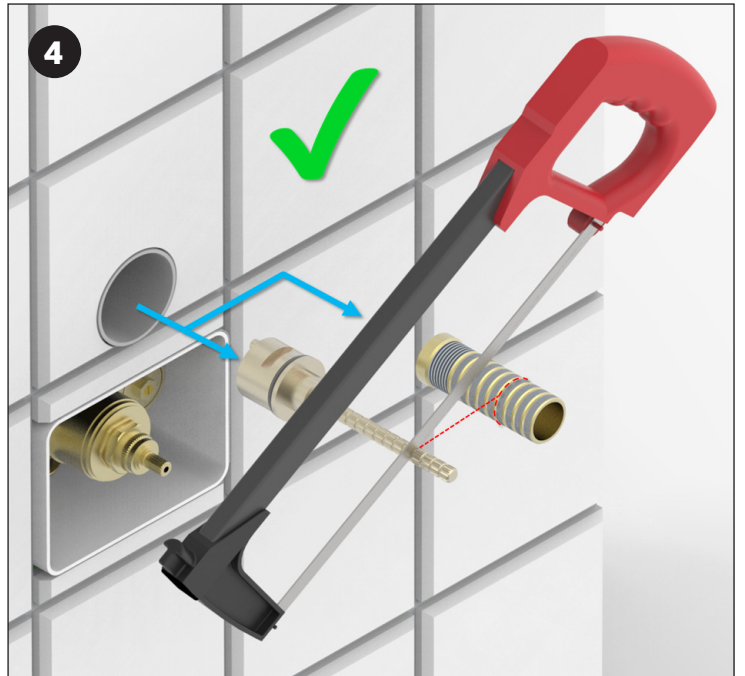
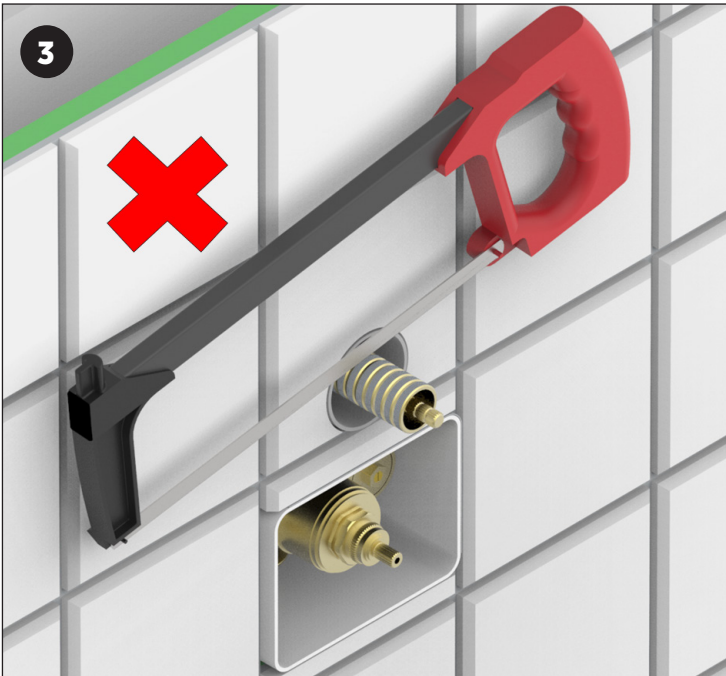
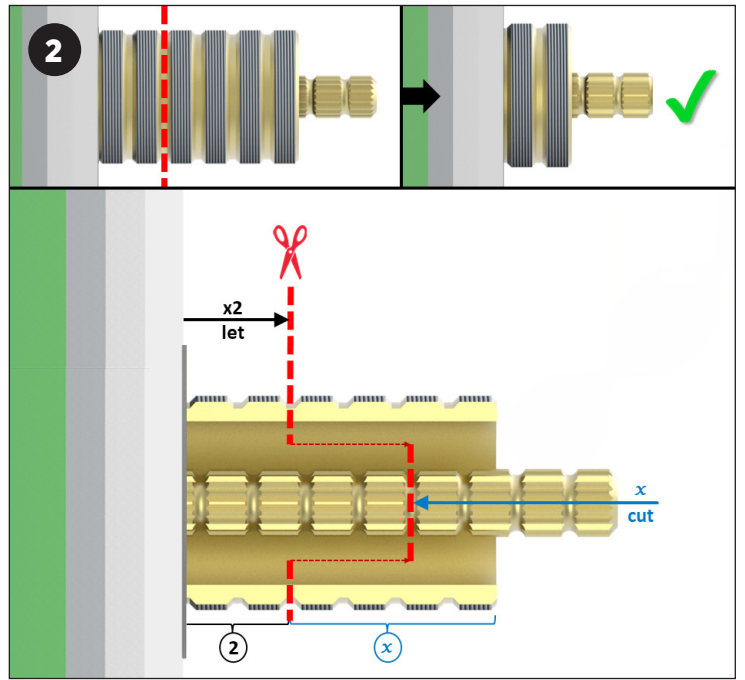
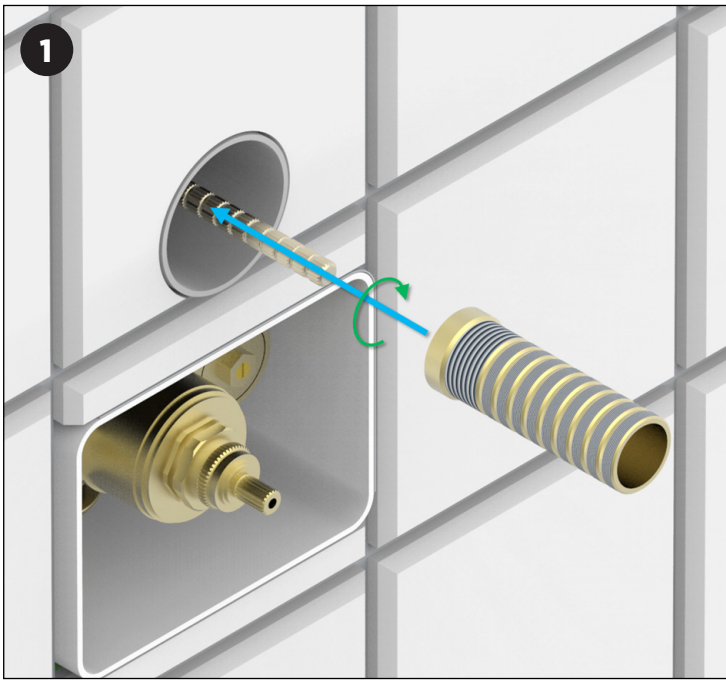

6
a

Ref.
G00.6596

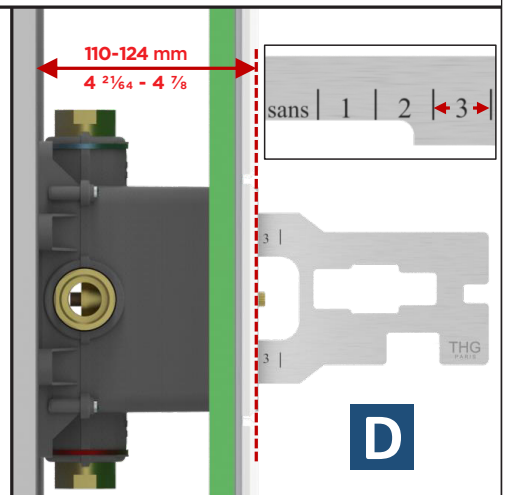
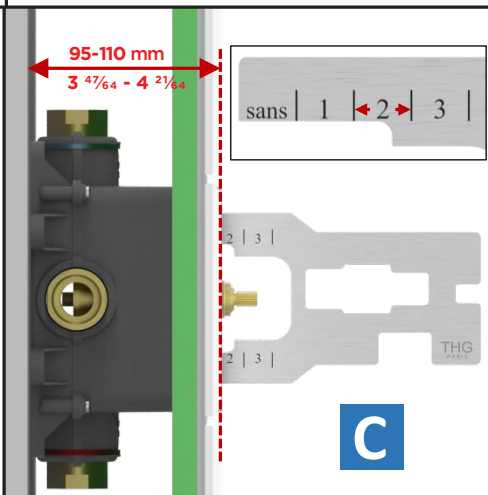
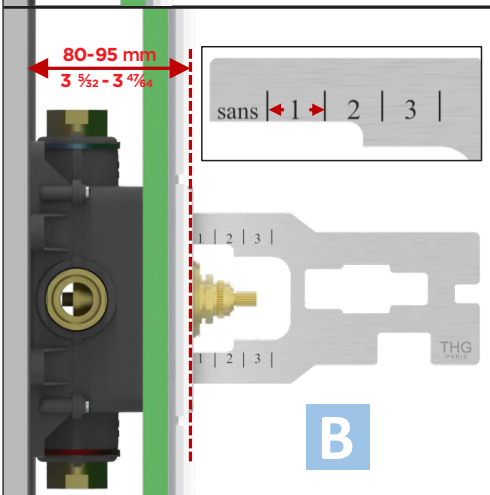
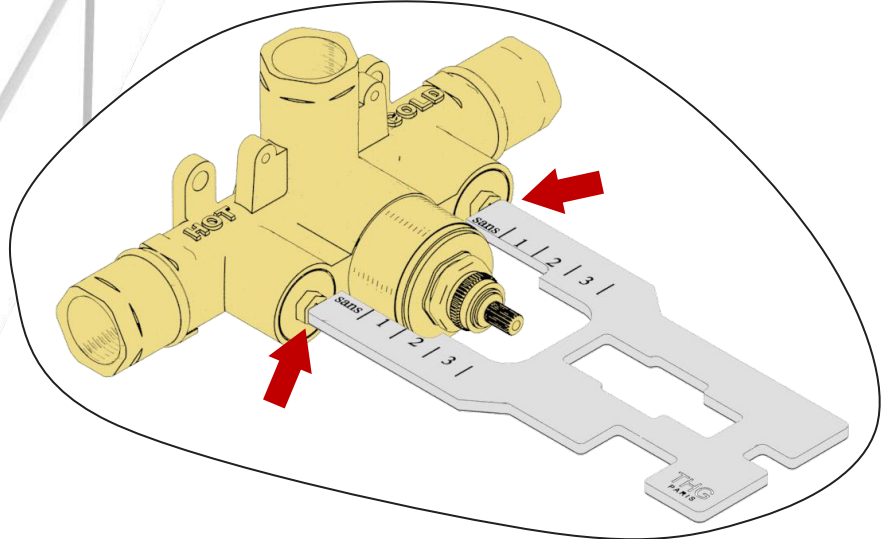
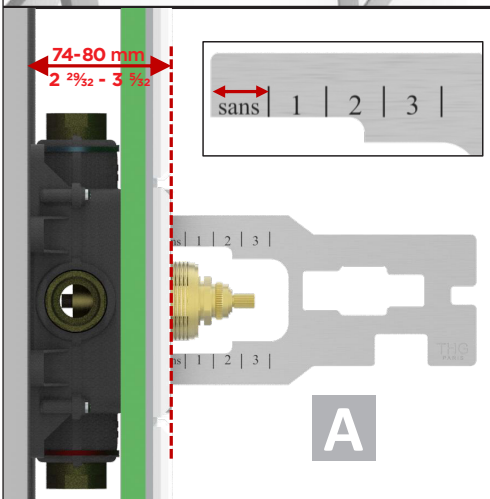
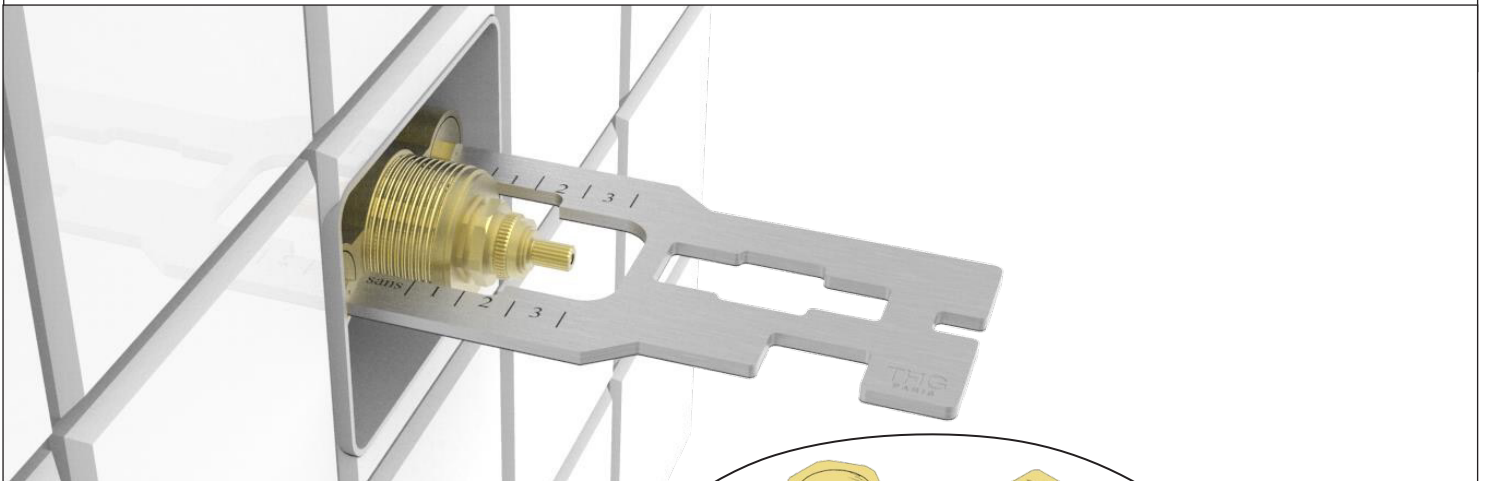
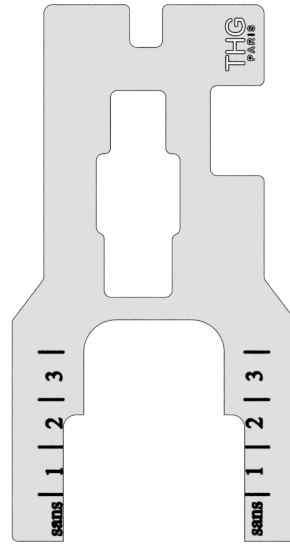

6b

ou
or
或
oder
o
o
of
или
أو

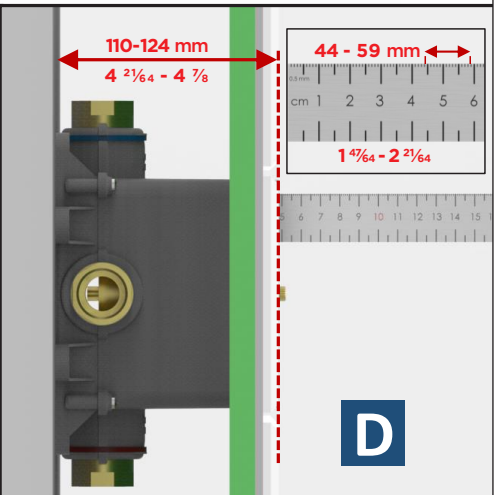
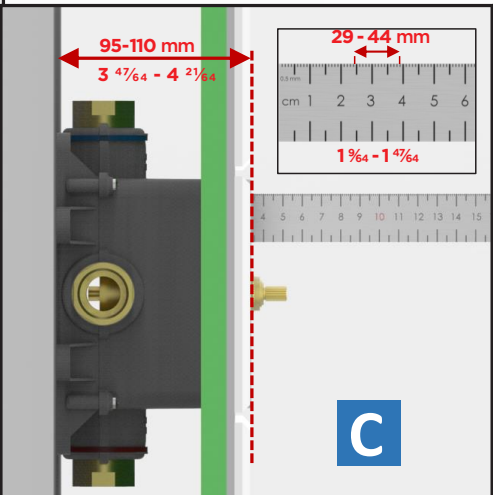
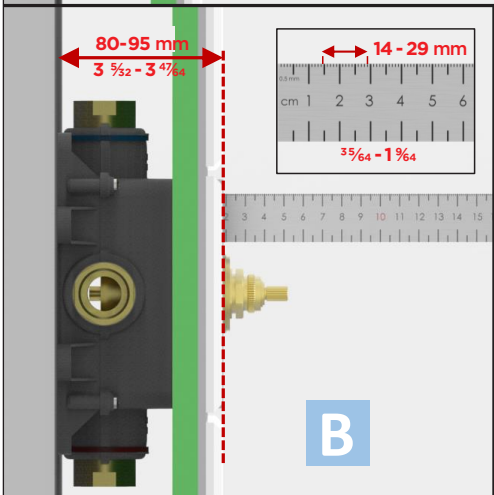
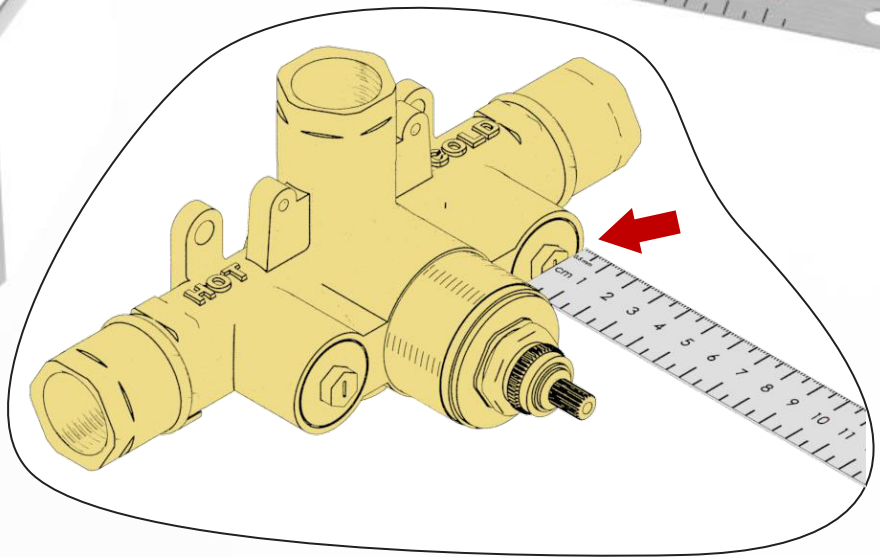
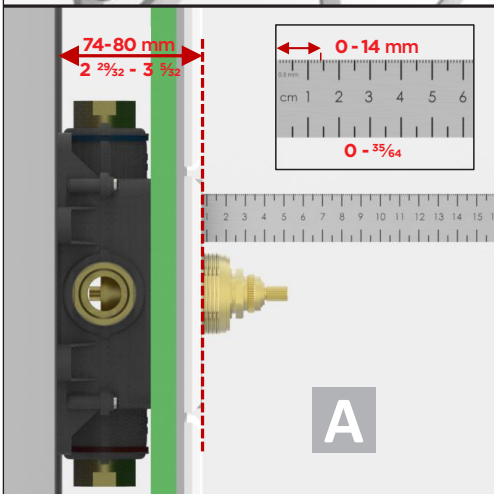
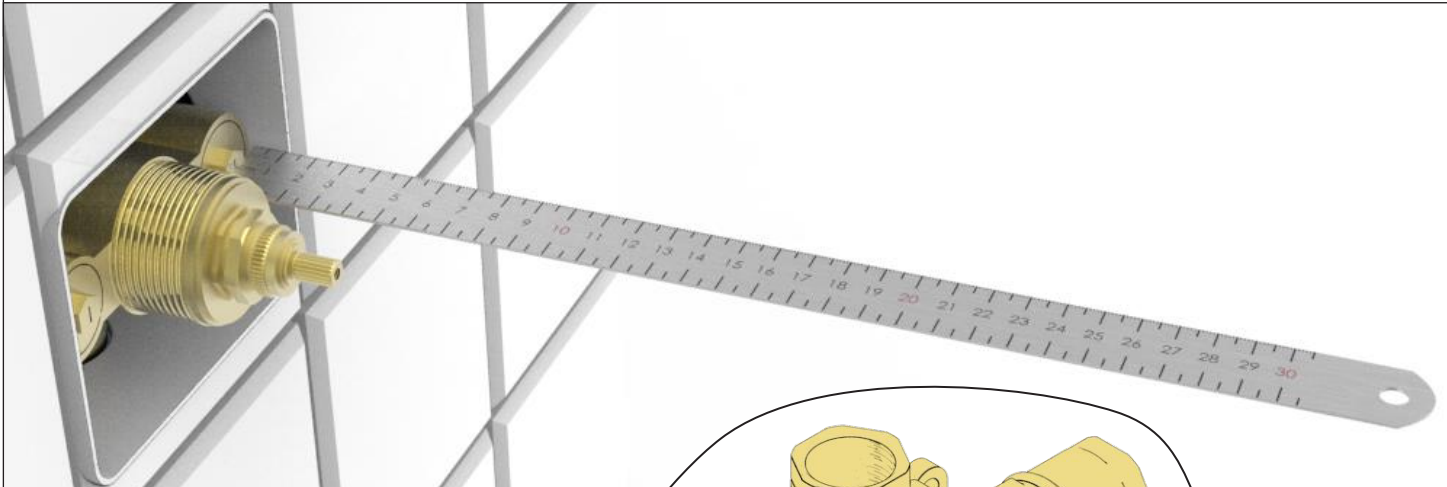
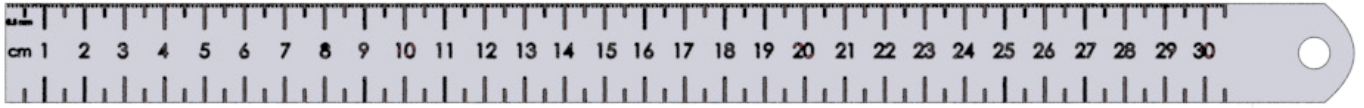

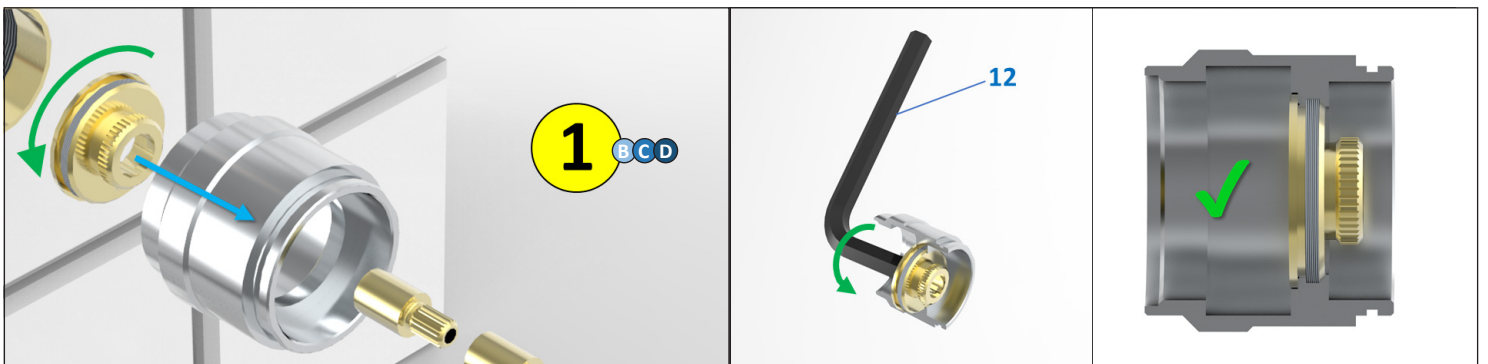
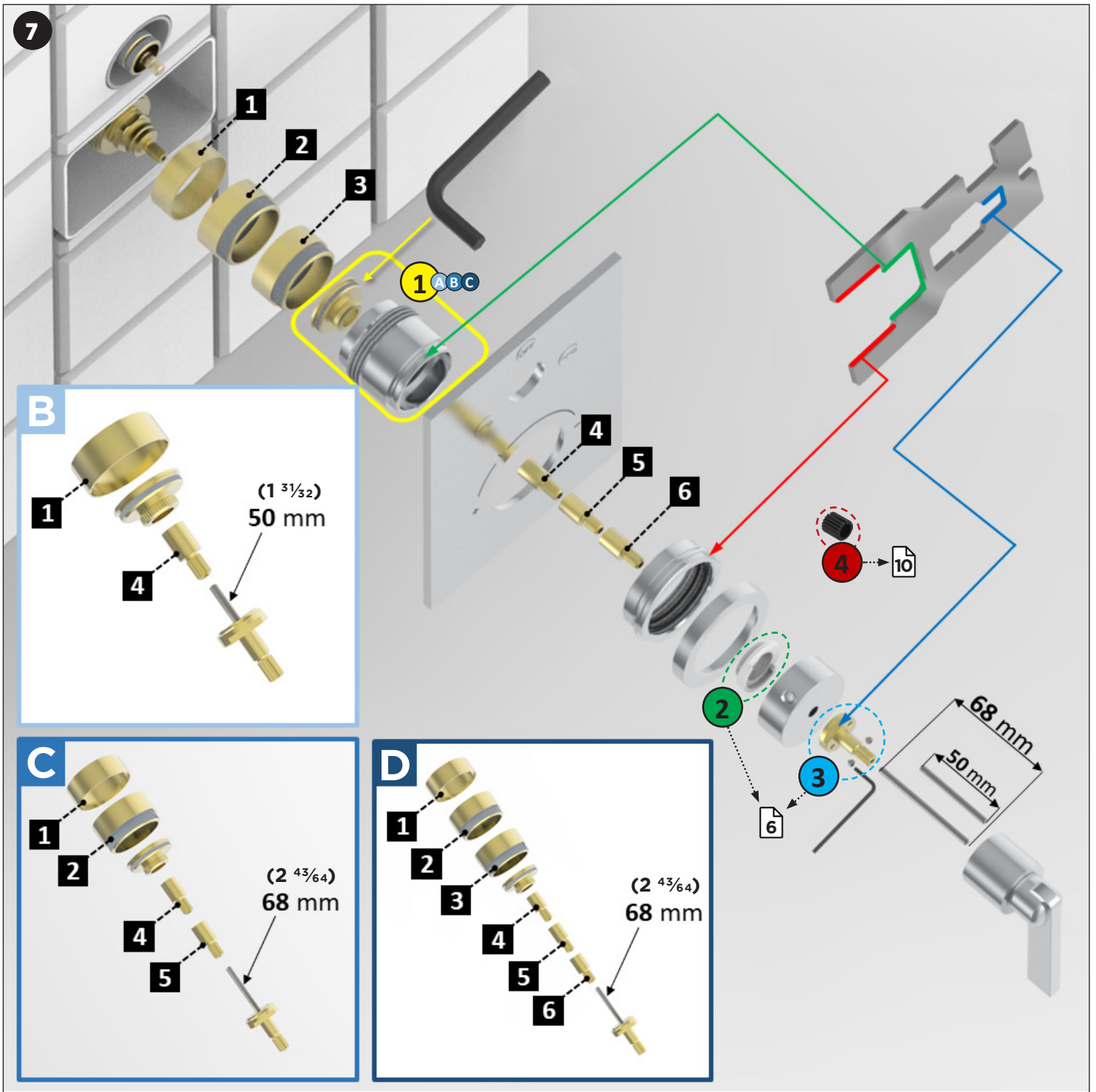

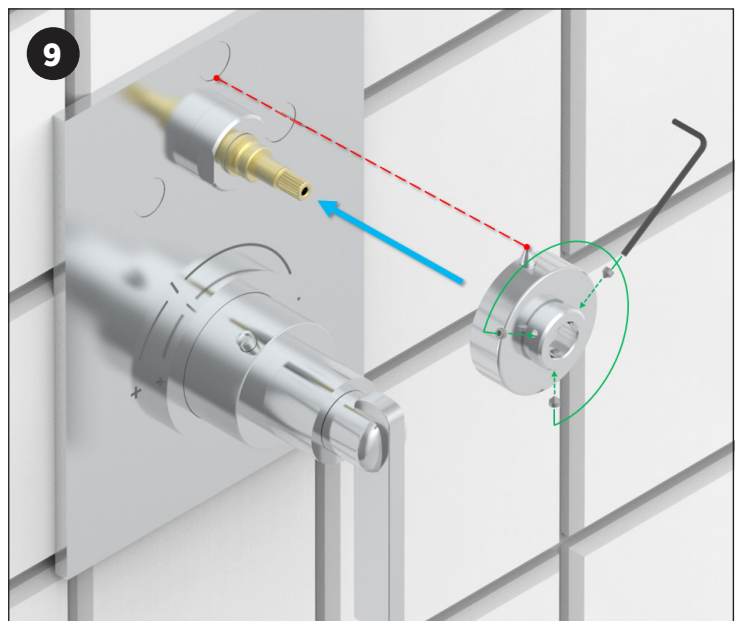
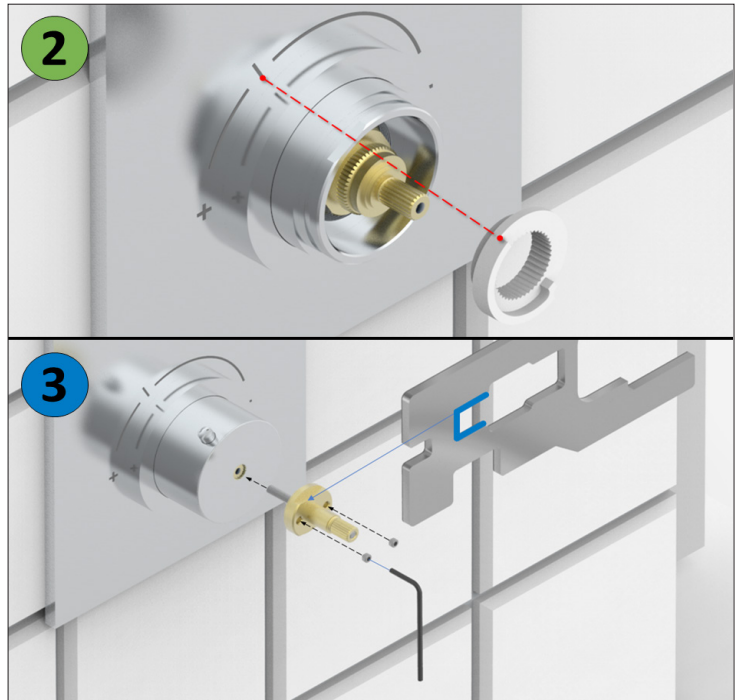
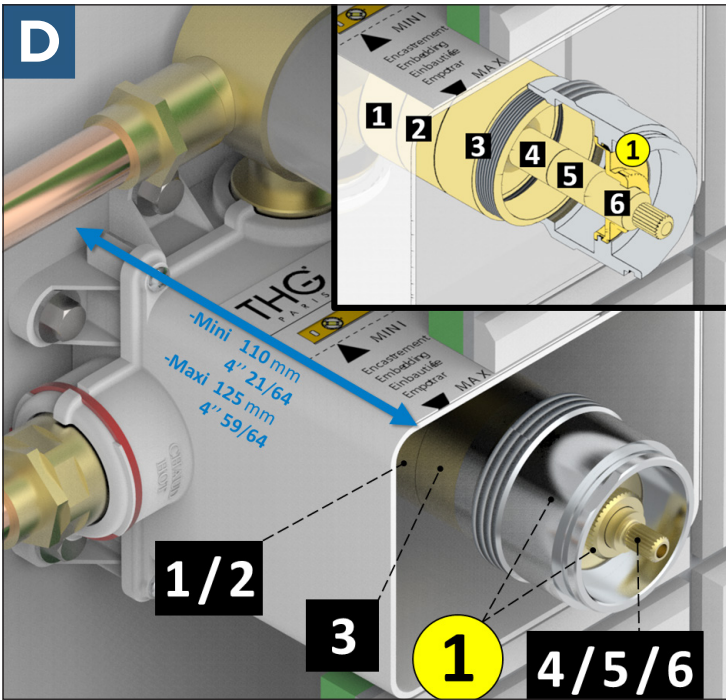
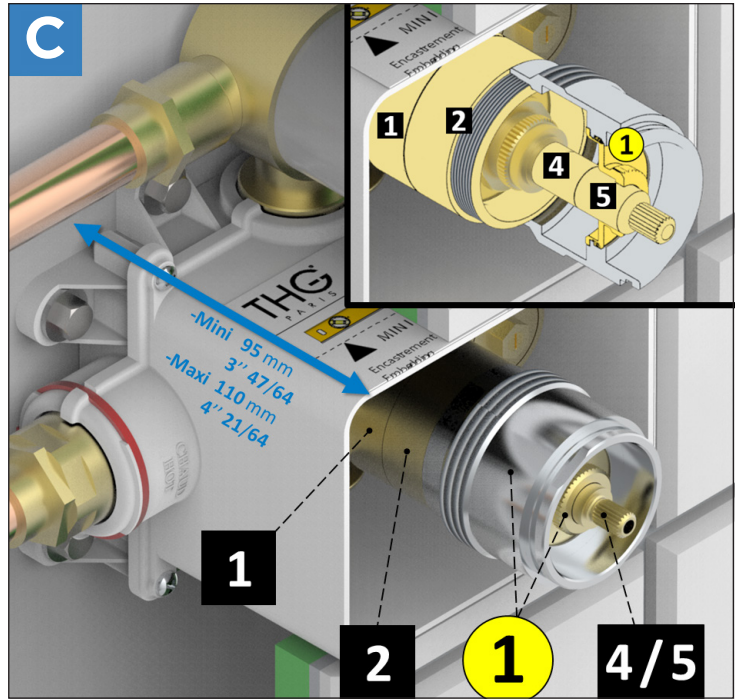
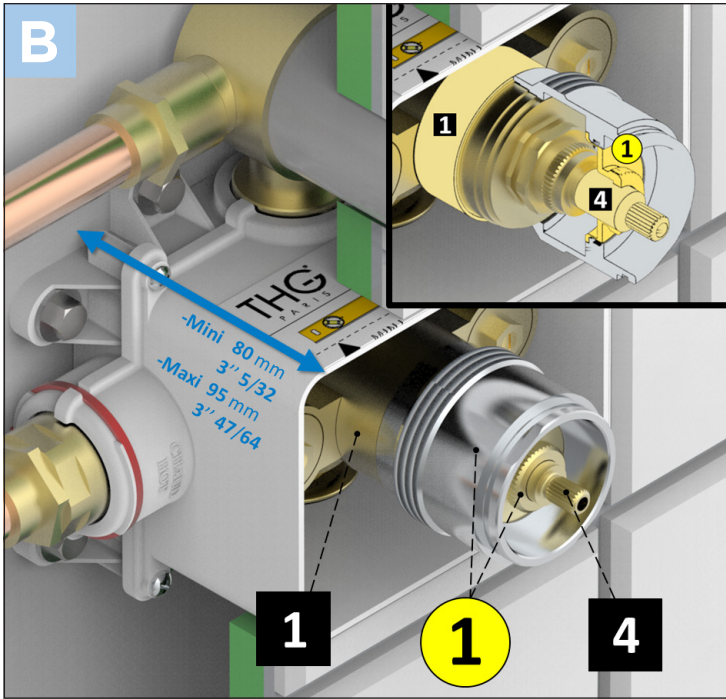

Montage des croisillons / manettes

Handle / lever assembly

装配十字接头 / 手柄

Montage von Traversen / Armaturen

Montaje de separadores/palancas

Montaggio dei transetti/manopole

Montage kraanknoppen/handgreep

Монтаж крестообразных рукояток / рычагов

تركيب ضوابط صليبية/مقابض

10

4 cas possibles

4 possible cases

4 种可能的案例

4 mögliche Fälle

4 casos posibles

4 casi possibili

4 gevallen mogelijk

4 варианта возможны

4 حالات ممكنة

1

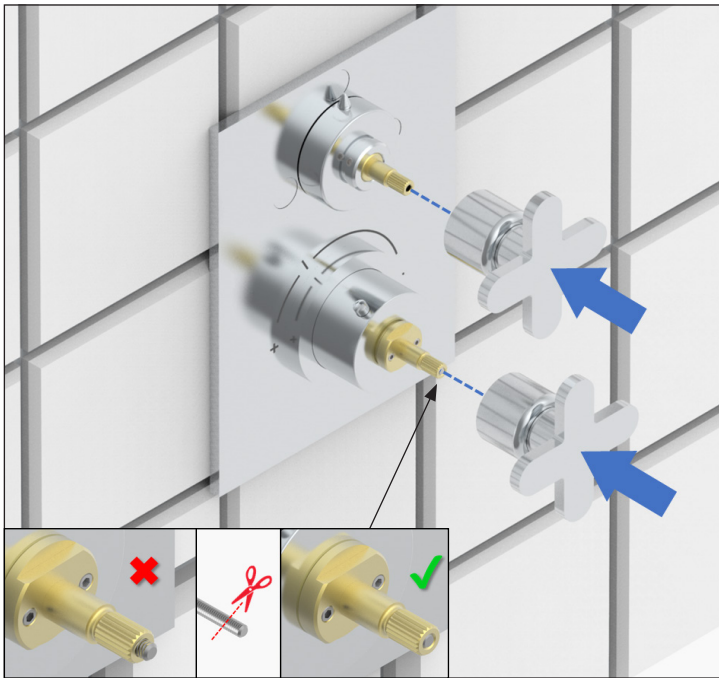

2

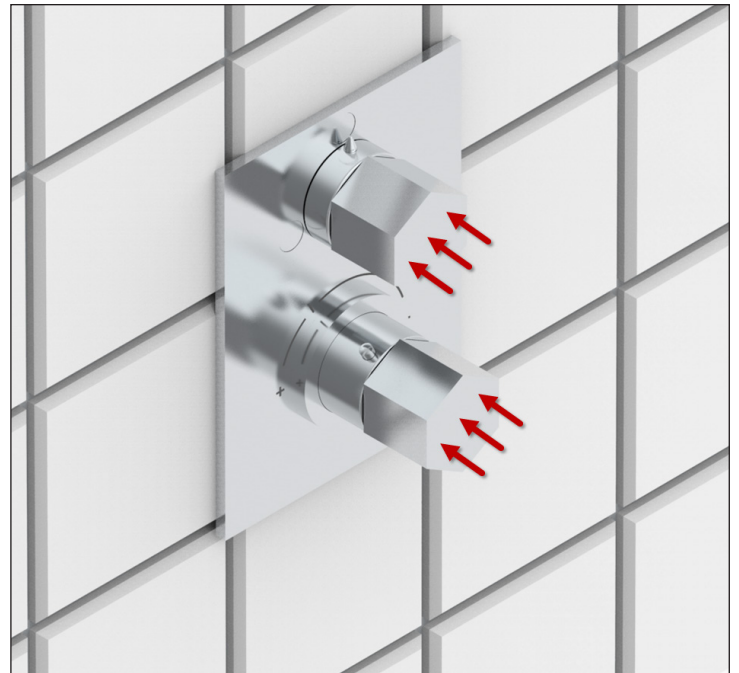
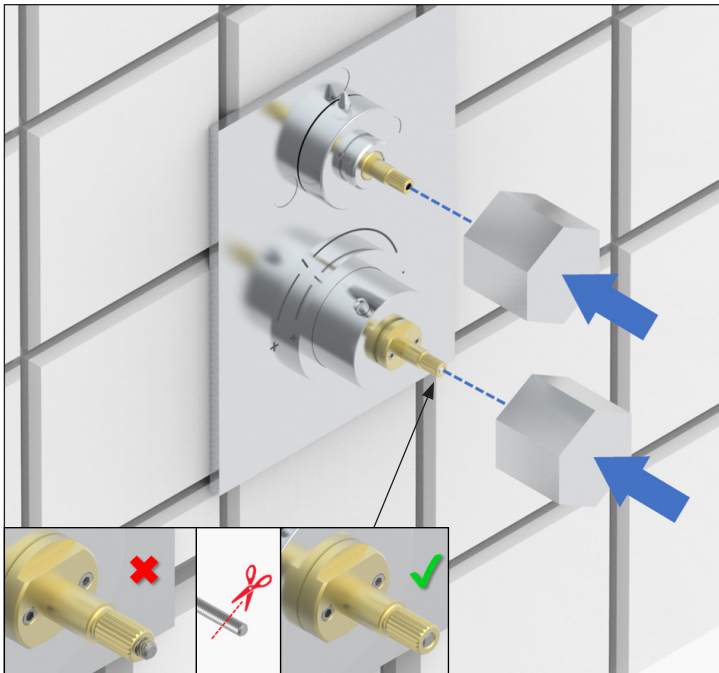

3

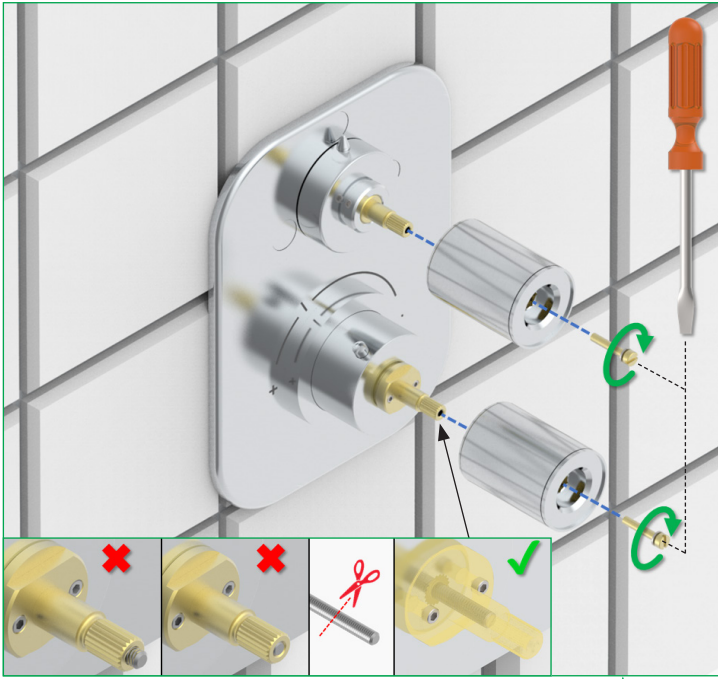

4

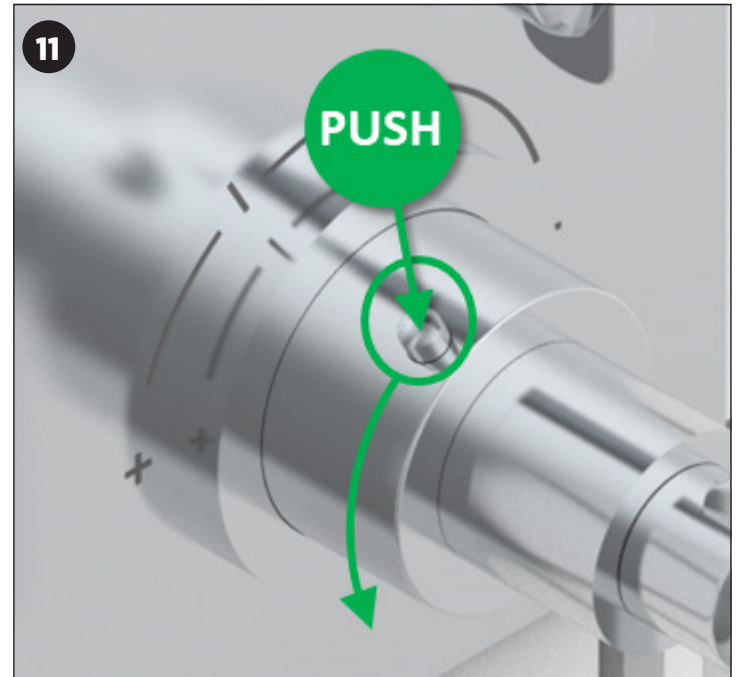
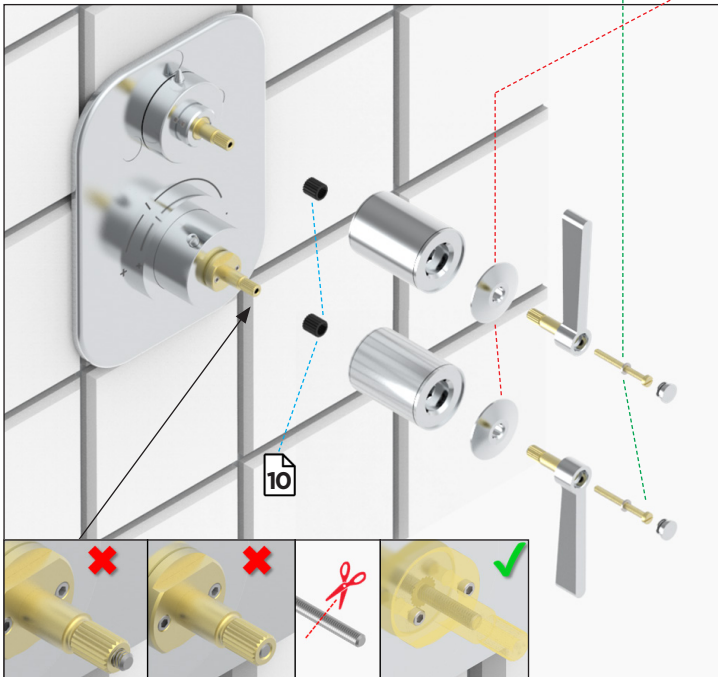

Réglage de température / Temperature adjustment / 温度校准 / Temperatureinstellung / Ajuste de temperatura / Regolazione della temperatura / Instellen van temperatuur / Регулировка температуры / ضبط الحرارة

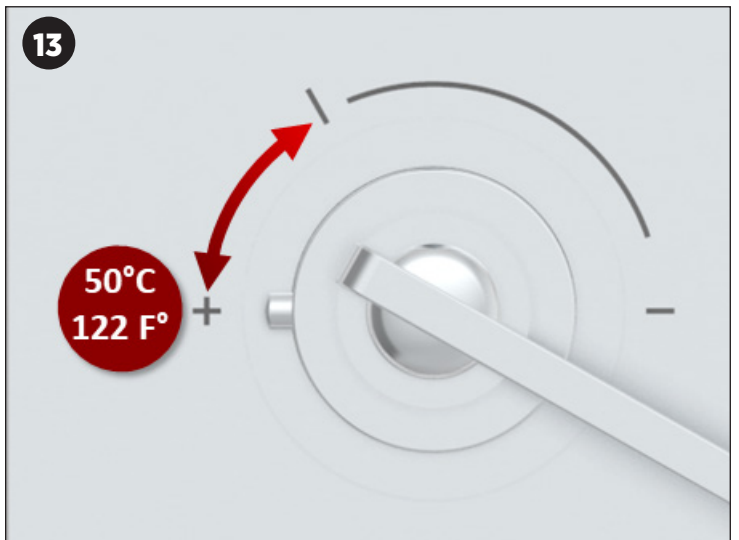
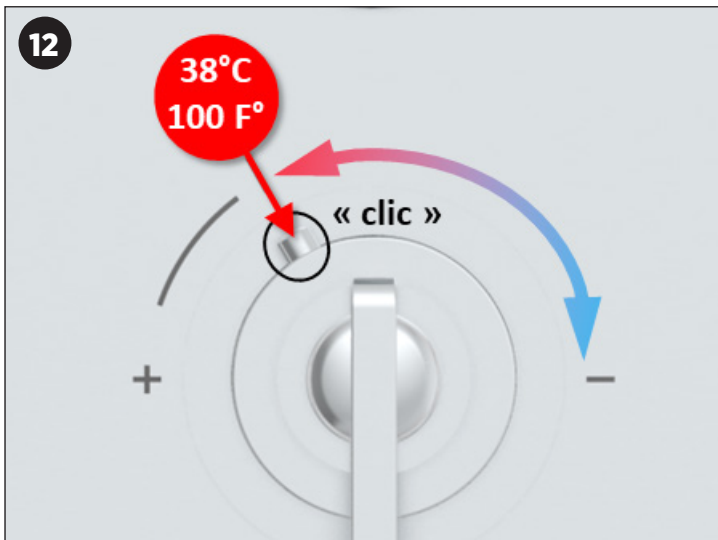

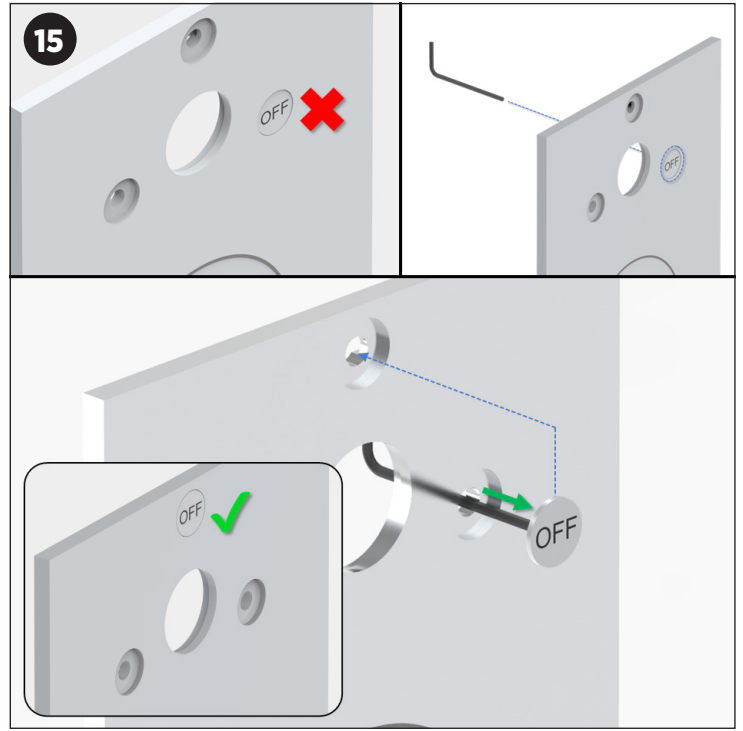
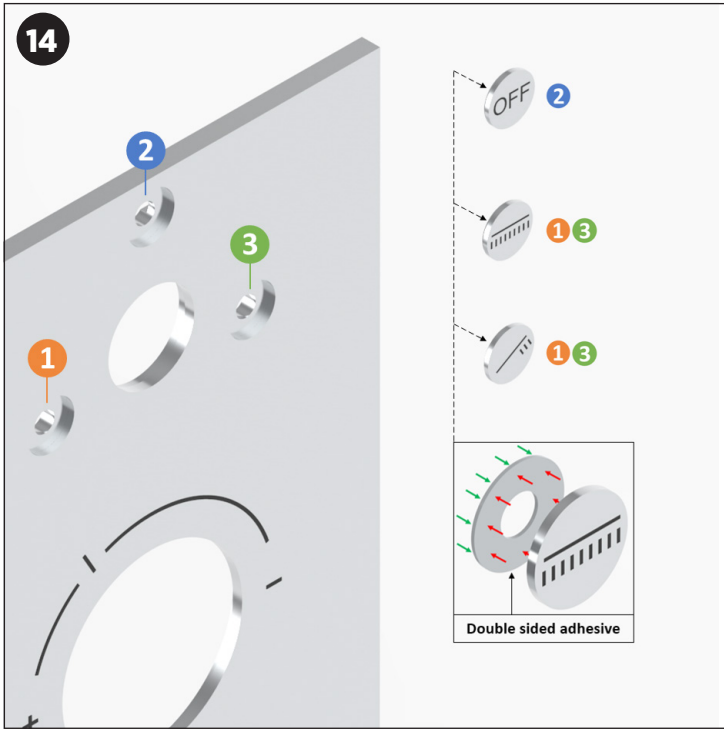

Insert plastique strié

Notice d'installation / Installation instructions / 安装说明 / Installationsanleitung / Instrucciones de instalación / Istruzioni per l'installazione / Installatie handleiding / Инструкции по установке / إرشادات التركيب

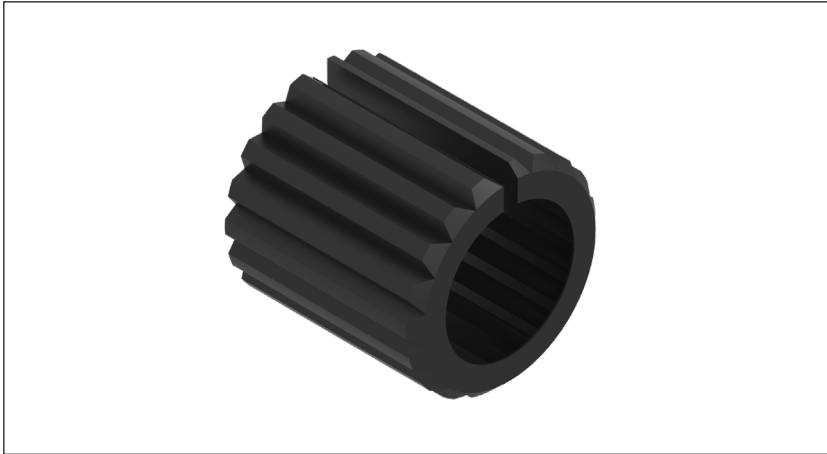

- FR** Insert plastique strié
- EN** Grooved plastic insert
- CN** 条纹塑料插件
- DE** Geriffelter Kunststoffeinsatz
- ES** Inserto plástico estriado
- IT** Inserto in plastica striata
- NL** Gegroefde kunststof inleg
- RU** Пластиковая рубчатая прокладка

ملحق بلاستيكي مُحزَّر **AR**

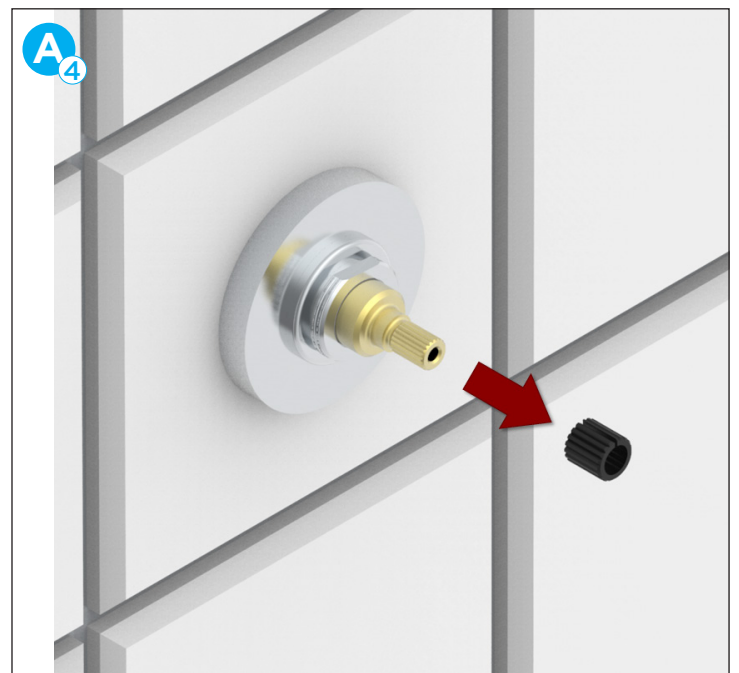
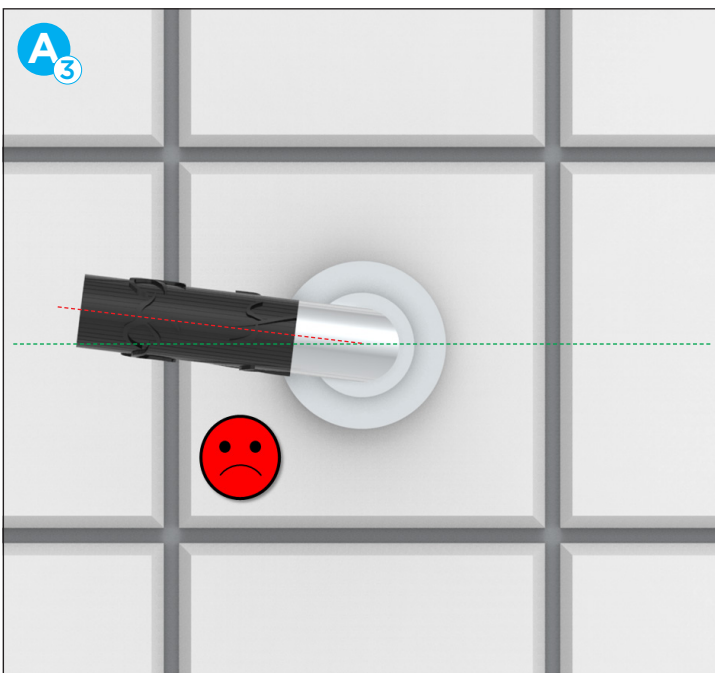
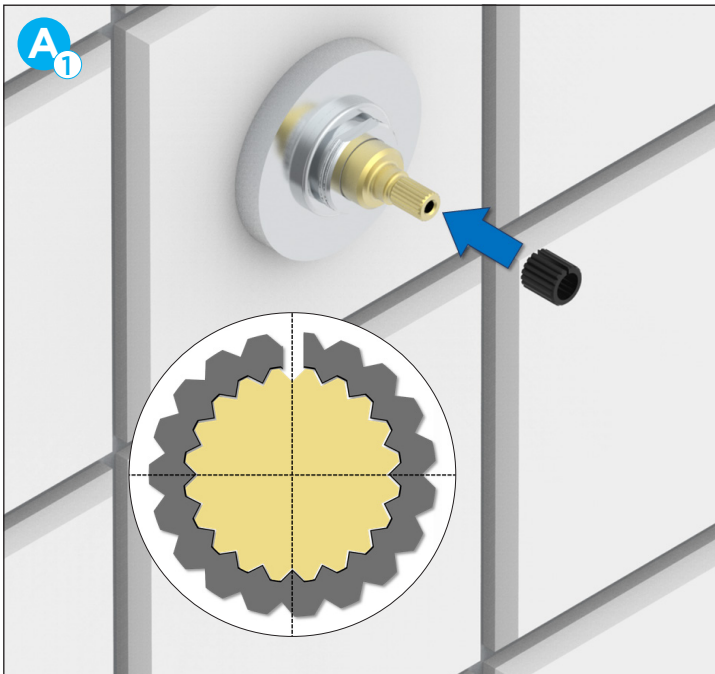

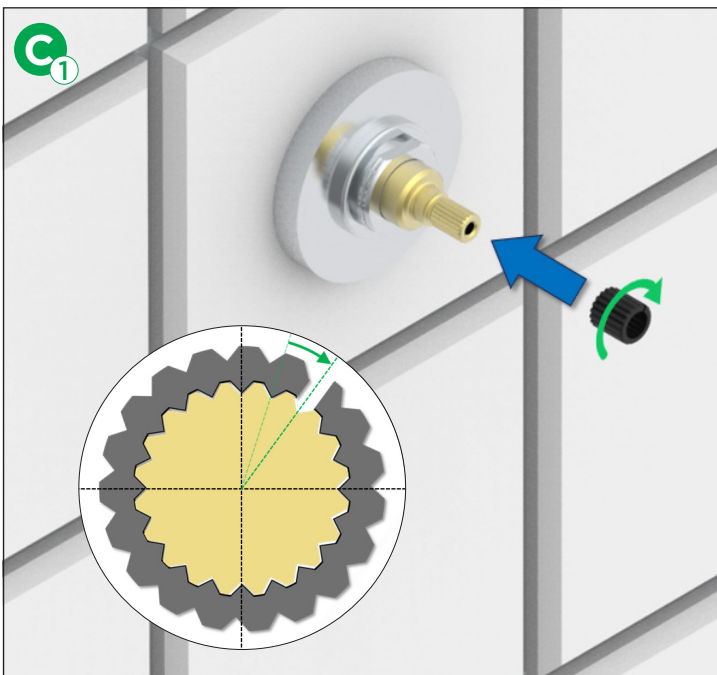
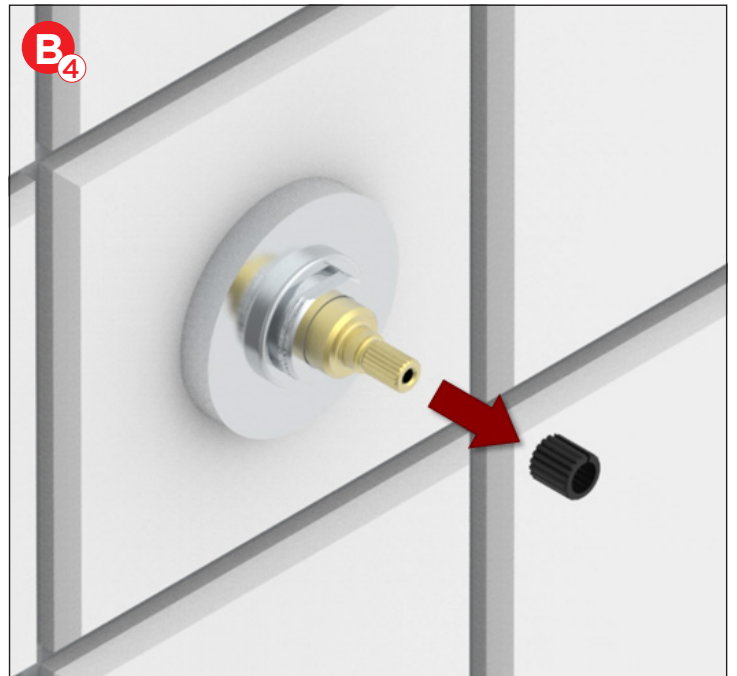
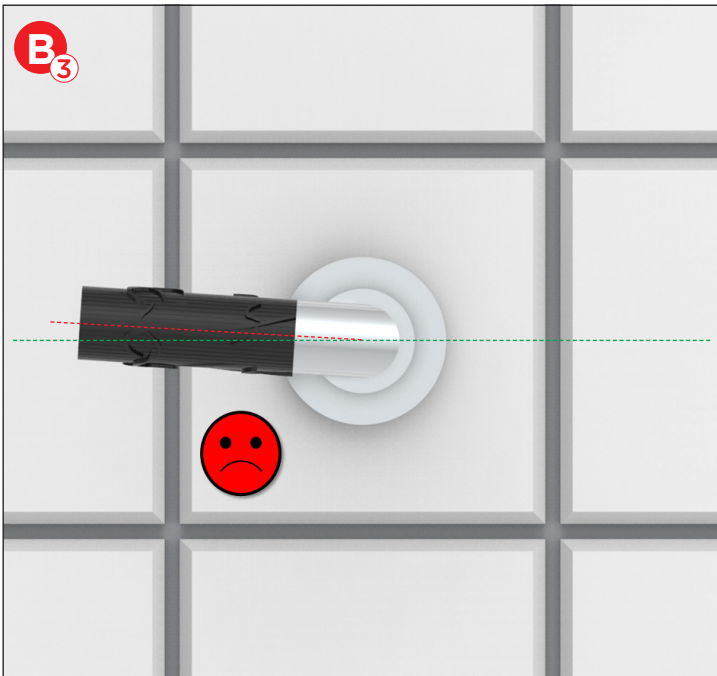
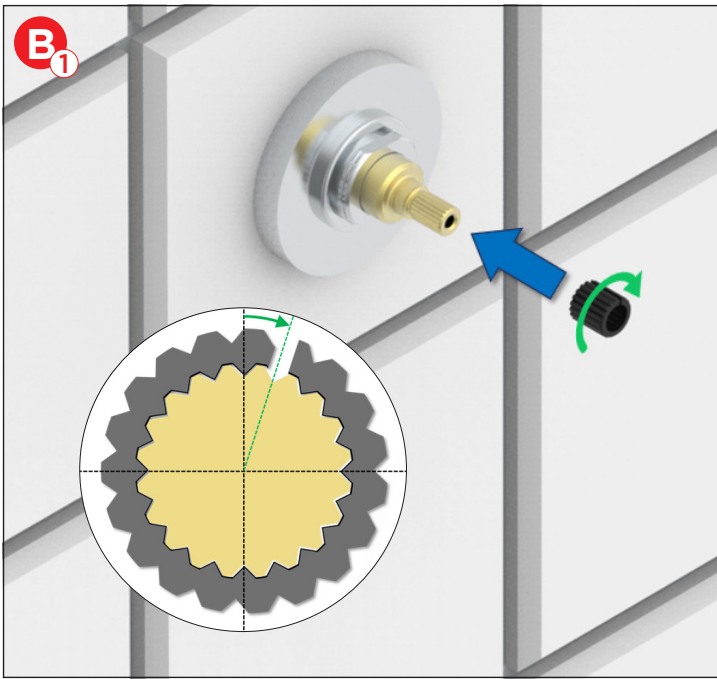

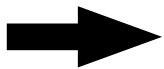
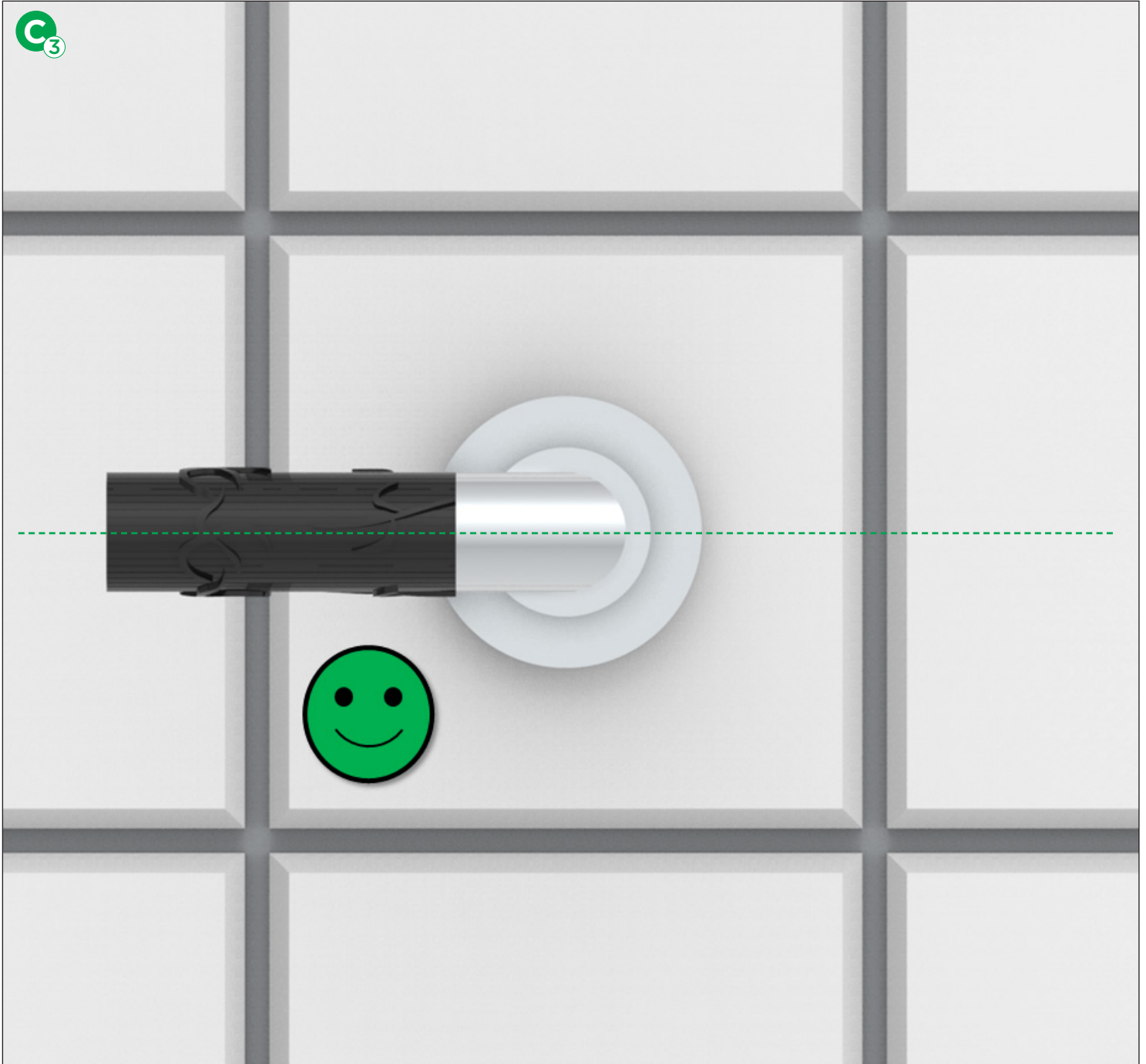

Répéter l'opération jusqu'à obtenir la position verticale ou horizontale (19 positions possibles)

Repeat the procedure until you obtain the right vertical or horizontal position (19 possible positions)

重复操作，直达到垂直或水平位置（可能有 19 个位置）

Wiederholen Sie den Vorgang, bis die vertikale oder horizontale Position erreicht ist (19 mögliche Positionen)

Repetir la operación hasta obtener la posición vertical u horizontal (19 posiciones posibles)

Ripetere l'operazione fino al raggiungimento della posizione verticale o orizzontale (sono possibili 19 posizioni)

Herhaal de handling totdat u de verticale of horizontale positie bereikt (19 mogelijke posities)

Повторяйте операцию, пока не достигнете вертикального или горизонтального положения (возможны 19 положений)

كرر العملية إلى غاية الحصول على الوضع العمودي أو الأفقي (٩١ وضعاً ممكناً)