

**180-8.3STP-\_\_**

Floor Mounted Bath Set with Hand Shower and Shut-Off Valves

Hand Shower Flow Rate: 1.75 GPM

Note: Some building codes require remote pressure balance valves for anti-scald

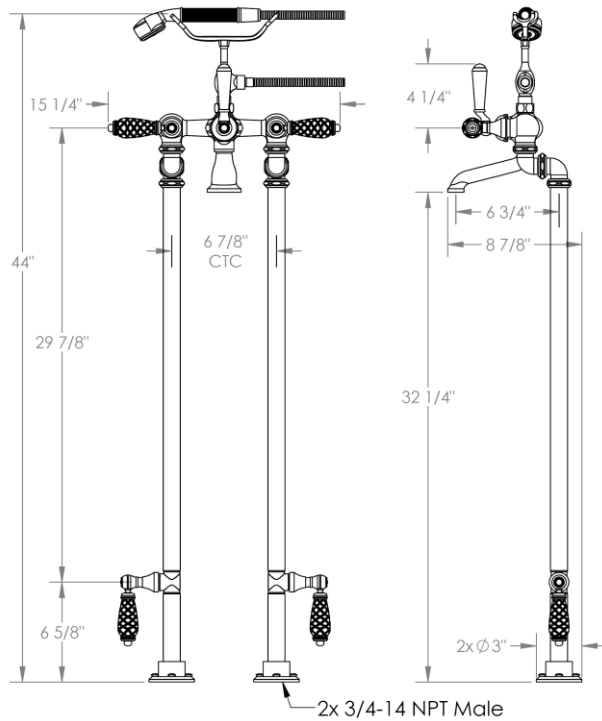
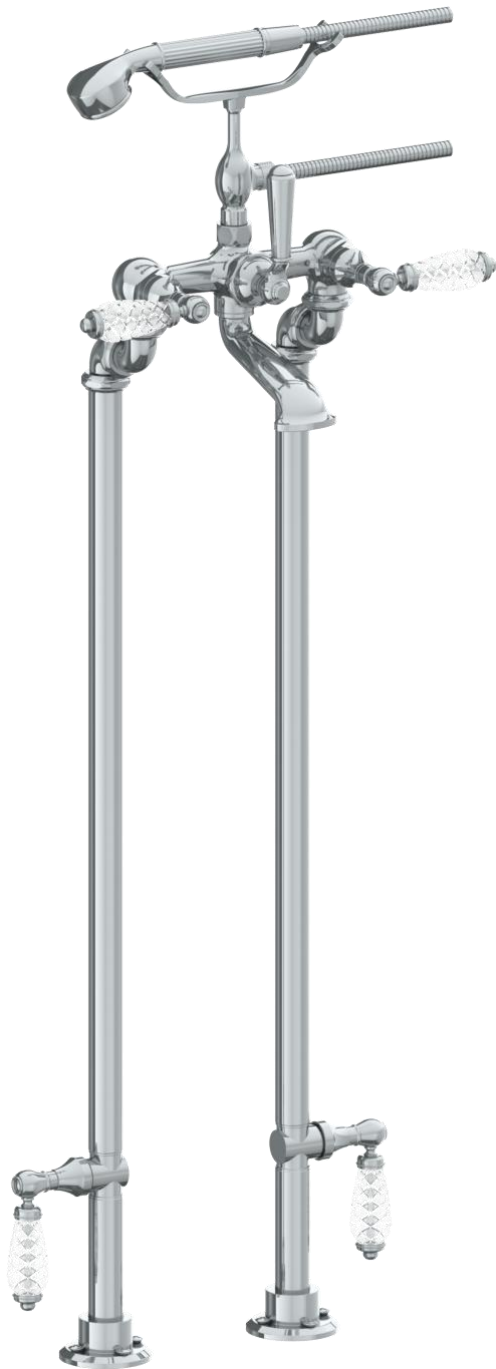

Meets the applicable requirements of ASME A112.18.1-2005/CSA B125.1-05, entitled "Plumbing Supply Fittings"

**WATERMARK DESIGNS**

**10/15/2018**

## HANDLE TRIM OPTIONS

AA - VENICE  
BB - GENOA

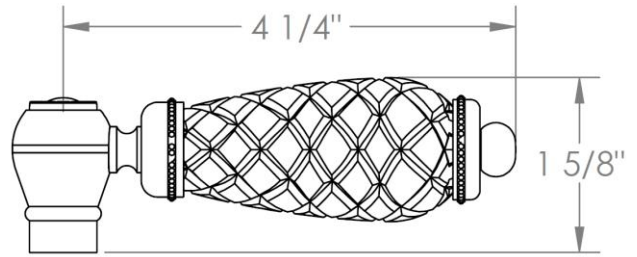

CC - POMPEI  
DD - NAPLES

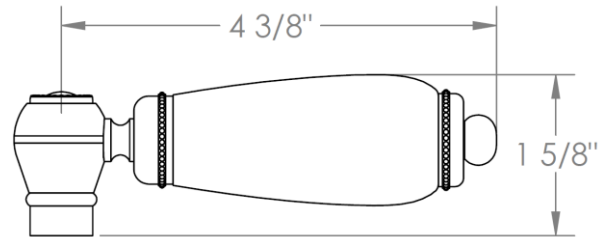
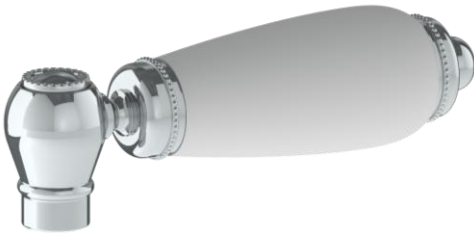

SWU - FLORENCE

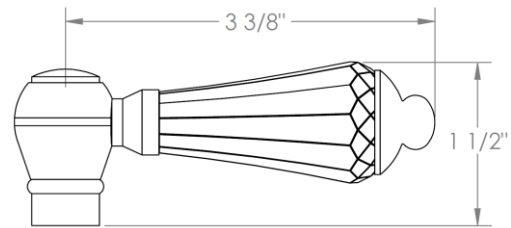

T - TUSCANY

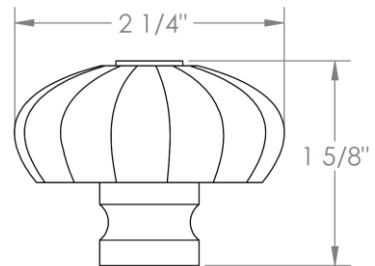

U - BOLOGNA

