

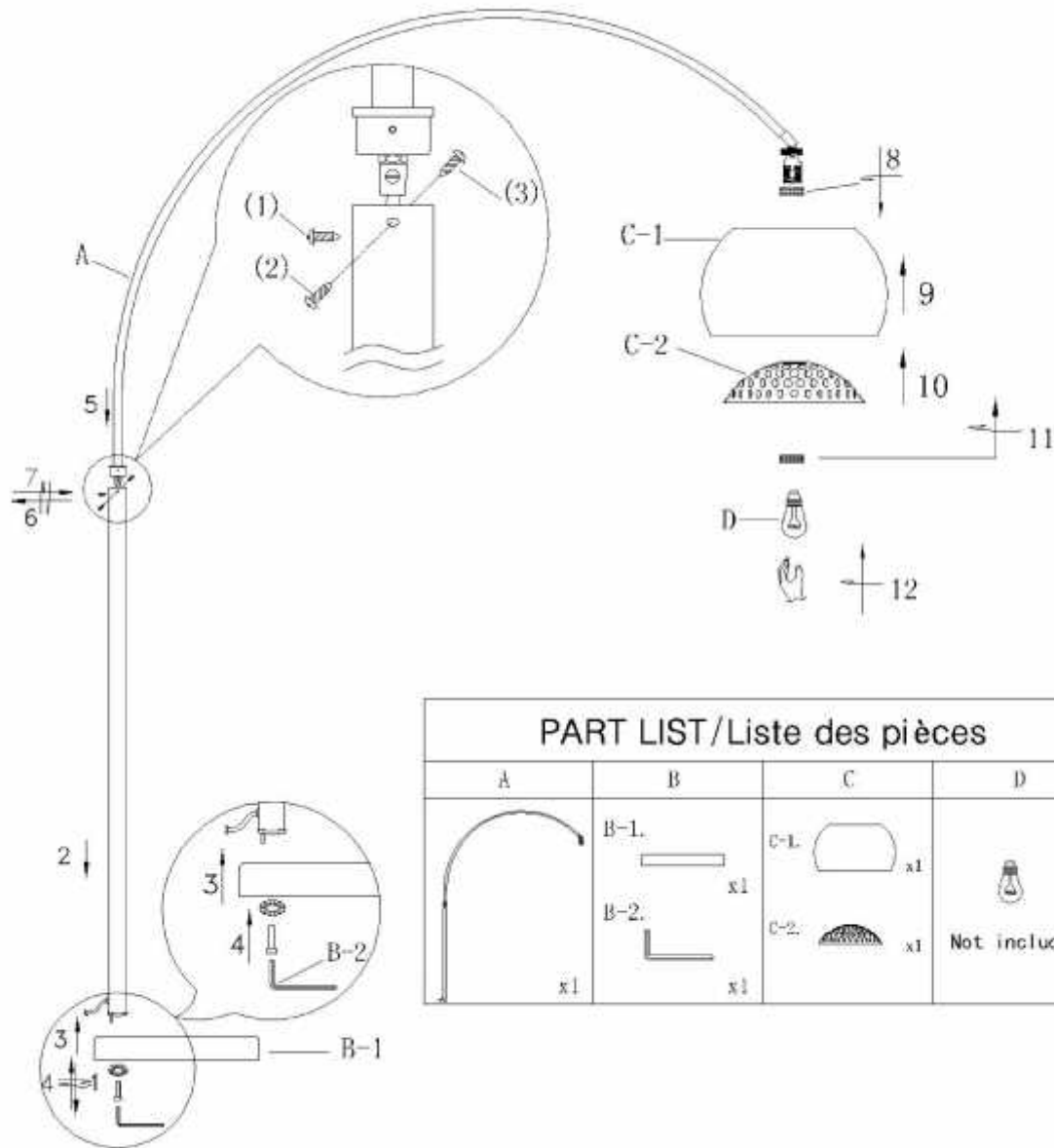

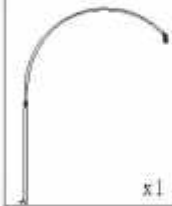



50019, Galactic Floor Lamp



PART LIST/Liste des pièces			
A	B	C	D
 x1	B-1.  x1 B-2.  x1	C-1.  x1 C-2.  x1	 x1 Not included

Assembly Instructions:

1. Before assembling, turn off the main power source.

2. Use one (1) E26 Max. 100W light bulb.

3. To avoid scratches and damages, do not use hard or sharp tools to assemble the lamp.

4. For their safety, keep children away from the electric parts of this lamp.

If the external wire or cable becomes damaged, only the manufacturer, service agent or a qualified electrician should repair it. Do not attempt to repair it yourself. This is a fire hazard.

Instructions d'Assemblage:

1. Avant l'assemblage, couper la source d'alimentation du courant électrique.

2. Utiliser une ampoule (1) E26 Max. 100W.

3. Pour éviter de faire des égratignures et dommages, ne pas se servir d'outils durs ou pointus pour assembler la lampe.

4. Pour leur protection, tenir les enfants loin des conduits électriques.

Si un fil ou câble extérieur se brise, faire réparer seulement par le fabricant, son agent ou une personne qualifiée afin d'éviter tout danger.

Screw in screw (1) into the hole and do not tighten it completely.

While another person holds the lamp base, move the lamp by pulling the arm.

Screw in screw (2) and (3), if they are not on the hole positions, please move around the poles to match the position of screws and holes.

Tighten the screws (1), (2), and (3) completely.

While another person holds the lamp base, move the lamp by pulling the arm.

Never move the lamp by pulling on the stem.